



# Annual Energy Audit Report Of

The Electricity Department of Andaman &  
Nicobar Administration

FY: 2023-24



Submitted to:

**Bureau of Energy Efficiency, New Delhi**

*in compliance of the Bureau of Energy Efficiency (Manner and Intervals for Conduct of Energy Audit in electricity distribution companies) Regulations, 2021*

Accredited Energy Auditor

Dr. Ravi Deshmukh  
(AEA-0243)





# Annual Energy Audit Report of The Electricity Department of Andaman & Nicobar Administration

**FY: 2023-24**





**Submitted By**

**PPS** Energy Solutions  
THE POWER OF ENERGY

**Nov - 2024**

## Document Submission

Action	By	Date	Version
Submitted	PPS Energy Solutions	15.11.2024	R0

Designation	Name	Signature
Accredited Energy Auditor	Dr. Ravi Deshmukh (AEA – 0243)	 





# Acknowledgement

We express our sincere gratitude to the authorities of The Electricity Department of Andaman & Nicobar Administration for entrusting and offering the opportunity of energy performance assignment.

We express our sincere gratitude to the Electricity Department of the Andaman & Nicobar Administration and its officials for their invaluable guidance and unwavering support throughout the system mapping and energy efficiency assessment of the sampled electrical distribution system. Their timely assistance and collaboration were instrumental in the successful and timely completion of the field studies





## Table of Contents

<b>1</b>	<b>Executive Summary</b> .....	<b>7</b>
1.1	Energy Accounts and Performance for FY 2023-24 .....	7
1.2	EDA & N Administration Introduction .....	8
1.3	About Assignment.....	9
1.4	Study Team .....	9
1.5	Methodology.....	9
1.6	The overall loss of the EDA & N for 2023-2024 year .....	11
<b>2</b>	<b>Background</b> .....	<b>12</b>
2.1	Extant Regulations and Role of BEE .....	12
2.2	Role of BEE .....	15
2.3	Purpose of Audit and Accounting Report .....	16
2.4	Period of Energy Auditing and Accounting .....	16
<b>3</b>	<b>Discom Introduction &amp; Overview</b> .....	<b>17</b>
3.1	Name and Address of DISCOM.....	17
3.2	Name and Contact Details of Energy Manager and Authorised Signatory of DISCOM (Nodal Officer) .....	17
3.3	Summary Profile of EDA&N .....	17
3.4	Energy Conservation Measures Already Taken and Proposed for Future.....	23
<b>4</b>	<b>Energy Flow Analysis</b> .....	<b>24</b>
4.1	Energy Flow across Service levels: .....	24
4.2	Validation of metered data.....	25
4.2.	Validation of Energy Flow Data & Losses:.....	28
<b>5.</b>	<b>Loss &amp; Subsidy Computation</b> .....	<b>29</b>
5.1.	Energy Accounts of FY 2023-24 .....	29
5.2.	Energy Accounts Analysis for Previous Year (FY 2022-23).....	32
5.3.	Energy Accounts Analysis and Performance of FY 2023-24.....	34
5.4.	Subsidy Computation and Analysis (based o quarterly data) .....	38
5.5.	Trend Analysis of EDA & N .....	38
<b>6.</b>	<b>Energy Audit Findings</b> .....	<b>39</b>
6.1.	Review of capacity of DISCOM’s energy accounting and audit Cell-T .....	39
6.2.	Critical Analysis by Energy Auditor .....	39
6.3.	Status of Various Compliance .....	40
6.4.	Pre-requisite of Annual Energy Audit of EDA & N: .....	40
6.5.	Revised findings based on data validation and field verification .....	47
6.6.	Inclusion and Exclusions .....	47
<b>7.</b>	<b>Conclusion and Action Plan</b> .....	<b>48</b>
7.1.	Summary of Critical Network Analysis by Energy Auditor .....	48





Annual Energy Audit of EDA&N FY 2023-24

7.2. Summary of Key Findings-Energy balance and losses .....	52
7.3. Recommendation– Energy Accounting, Loss reduction and energy conservation .....	52
7.4. Action Plan for monitoring and reporting.....	54
7.5. Action plan for automated energy accounting.....	54
<b>8. ANNEXURES .....</b>	<b>55</b>
Annexure I- Introduction of Verification Firm.....	55
Annexure II -Minutes of Meeting with the DISCOM team.....	56
Annexure III - Check List prepared by auditing Firm.....	60
Annexure IV - Brief Approach, Scope & Methodology for audit.....	61
Annexure V - Infrastructure Details .....	61
Annexure VI - Electrical Distribution System .....	62
Annexure VII – Power Purchase Details.....	65
Annexure VIII Line Diagram (SLD) .....	66
Annexure IX - Category of service details (With Consumer and voltage- wise) .....	69
Annexure X Field Verification Data and Reports (Photographs).....	70
Annexure XI-List of documents verified with each parameter .....	77
Annexure XII -Brief Description of Unit.....	77





## List of Tables

Table 1 DISCOM WIDE ENERGY ACCOUNTING .....	7
Table 2 The technical losses and AT & C losses for FY 2023-2024 .....	7
Table 3 the total sales for various consumer categories.....	8
Table 4 : EDA & N Team.....	9
Table 5 : PPSSES Team .....	9
Table 6 Overall Loss of EDA & N .....	11
Table 7 Details of Energy Manager and Authorized Signatory of DC.....	17
Table 8 Infrastructure Details .....	17
Table 9 Energy Flow of EDA&N.....	18
Table 10 Category wise Consumer Details .....	20
Table 11 Metering Status at different Voltage Levels .....	20
Table 12: Customer Profile for FY 2023-24.....	21
Table 13: Voltage wise Meter Consumers.....	21
Table 14: Numbers of Distribution Transformers .....	22
Table 15: Voltage wise numbers of Feeders .....	22
Table 16: Length of Distribution Lines.....	22
Table 17 Schedule of the Work .....	25
Table 18 Division Wise Losses .....	32
Table 19 Net Energy Input to EDA&N.....	34
Table 20 Summary of Losses of EDA&N .....	34
Table 21 Category wise Energy Account of EDA&N .....	34
Table 22 Division wise Performance.....	35
Table 23 : Different Types of Meter connection in EDA & N.....	36
Table 24 : T & D loss category wise .....	37
Table 25 : Category wise AT & C loss.....	37
Table 26 Purchased Energy FY 2023-2024.....	48
Table 27 Billed energy FY 2023-2024 .....	48
Table 28 : Details of Consumer.....	51
Table 29: Energy balance and losses .....	52



## 1 Executive Summary

Bureau of Energy Efficiency (BEE) notified the Bureau of Energy Efficiency (Manner and Intervals for Conduct of Energy Audit (Accounting) in Electricity Distribution Companies) Regulations, 2021 on 6th October 2021. As per the regulation, all Electricity Distribution Companies are mandated to conduct annual energy audit and periodic energy accounting on quarterly basis. Owing to the impact of energy auditing on the entire distribution and retail supply business and absence of an existing framework with dedicated focus on the same, it was imperative to develop a set of comprehensive guidelines that all Distribution utilities across India can follow and adhere to.

### 1.1 Energy Accounts and Performance for FY 2023-24

#### 1.1.1 DISCOM's ENERGY ACCOUNTING

The estimated net energy input to the DISCOM for the fiscal year 2023-2024 is presented in tabular form below:

**Table 1 DISCOM WIDE ENERGY ACCOUNTING**

S. No.	Parameters	Period From 2023 To 2024
1	Net input energy (received at DISCOM periphery or at distribution point)-(MU)	368.33
2	T&D loss (%)	18.77
3	T&D loss (MU)	69.15
4	Energy sold outside the periphery (MU)	0.00
5	Open access sale (MU)	0.00
6	EHT sale	0.00

The following table shows estimated technical and AT&C losses for FY 2023-2024

**Table 2 The technical losses and AT & C losses for FY 2023-2024**

Total Losses	T&D Loss		Collection Efficiency (%)	AT& C Loss (%)
	T&D Loss (MU)	T&D Loss (%)		
	69.15	18.77%	96%	22%



## Annual Energy Audit of EDA&N FY 2023-24

The total sales (metered and assessed) for various consumer categories are presented in the following table:

Table 3 the total sales for various consumer categories

Sr. No	Type of Consumers	Category Of Consumers (EHT/HT/LT/Others)	Voltage Level (Voltage )	No of Consumers	Total Consumption (In MU)
1	Residential	LT	-	129580	168.10
2	Agricultural	LT	-	667	1.69
3	Commercial/Industrial- LT	LT	-	21525	68.34
4	Commercial/Industrial-HT	HT	-	0.00	0.00
5	Others	LT	-	2959	61.03
		<b>Total</b>		<b>154731</b>	<b>299.18</b>

## 1.2 EDA & N Administration Introduction

Andaman & Nicobar Islands (hereinafter referred to as “A&N”) is a cluster of islands scattered in the Bay of Bengal and a designated Union Territory of India. These islands are separated from the rest of India by more than 1000 kms. The total area of the territory is 8,249 sq.km out of which the forest cover is about 7,589 sq. km. (92%). A&N is having population of 379,944 as per census provisional records and average growth rate of population is 6.68%. These islands are divided in three districts, viz., Andaman, Nicobar and North & Middle Andaman. The seat of the Administration is at Sri Vijaya Puram (South Andaman) in which 14.14 sq. km. area is under the jurisdiction of Sri Vijaya Puram Municipal Council.

The tempo of economic development has tremendously accelerated along with all-round expansion in the areas/ sectors, viz., (i) Shipping Services, (ii) Civil Supplies, (iii) Education, (iv) Fisheries, (v) Tourism & Information Technology, (vi) Health, (vii) Industries, (viii) Rural Development, (ix) Social Welfare, (x) Transport, (xi) Increase in District Headquarters, (xii) Central Government Department, (xiii) Public Undertaking & other offices, (xiv) Services & Utilities, (xv) Defence Establishment, (xvi) Commercial Organizations/Business Centers, etc. Thus, these islands have reached the take off stage for total economic transformation. All these economic and infrastructure developments require power as a vital input and to play a key role for achieving overall transformation.







### 1.3 About Assignment

Bureau of Energy Efficiency (BEE) through Ministry of Power, Government of India issued regulations namely Bureau of Energy Efficiency (Manner and Intervals for Conduct of Energy Audit in electricity distribution companies) Regulations, 2021 (hereinafter referred as ‘BEE EA Regulation 2021’), for Conduct of Annual Energy Audit and Periodic Energy Accounting in DISCOMs.

As per the notification, the work of Energy Audit of EDA & N was awarded to PPS Energy Solutions Pvt. Ltd.

### 1.4 Study Team

As per the directives of team given by regulation, the teams were formed by EDA & N and PPSES to conduct the energy accounting and energy audit.

Table 4 : EDA & N Team

Sr. No	Name of Officer	Member of Energy Accounting Cell	Designation
1	Hema Devi	Nodal Officer	Assistant Engineer( PL-II)
2	Munmun Baral	Finance Manager	Assistant Accounts Officer
3	P.Subbaraj	IT Manager	Assistant Engineer (IT)
4	Under Process	Energy Manager	.....

Table 5 : PPSES Team

Sr. No.	Name	Designation
1	Dr. Ravi Deshmukh	Team Leader. Accredited Energy Auditor (AEA-0243)
2	Mr. Dinesh Baharate	Team member - Electrical Engg. (EA 24237) (Certified Energy Auditor)
3	Mr. Shashikant Puranic	Sector Expert - Electrical Engg.
4	Mr. Prasad Bhosale	Team member- (Certified Energy Manager)
5	Mr. Hemant Kadu	Team Member – Electrical Engg 2

### 1.5 Methodology

The methodology adopted,

1. Kick of meeting was done on 22<sup>nd</sup> September 2024 with EDA & N Team to finalize the sample size
2. Survey of the Distribution network





## Annual Energy Audit of EDA&N FY 2023-24

3. Collection of the Primary Data and finalization of the sample size check
4. Site visit and Energy Meter data collection
5. Collection of the Metered Energy Data for the respective voltage level as per the sample size
6. Scrutiny of collected data and Data gaps of the submitted data
7. Loss calculation for the network segment then if required normalization
8. Compilation of the Draft report
9. Presentation on Draft report
10. Final report with incorporation of comments

As per the methodology, after collection of the data, site visit carried out at EDA & N in month of September 2024, along with EDA & N Team and consultant team.





## 1.6 The overall loss of the EDA & N for 2023-2024 year

The below table shows the overall loss of EDA & N for FY 2023-2024.

During the FY 2023-2024, EDA & N has Input Energy at generation source of 382.45 Million kWh and net input energy at DISCOM periphery was 368.33 Million kWh. Billed Energy of the EDA & N for FY 2023-2024 was 299.18 Million kWh.

Table 6 Overall Loss of EDA & N

Performance Summary of Electricity Distribution Companies			
<b>1</b>	Period of Information Year of (FY) information including Date and Month (Start & End)	1st Apr, 2023 - 31st March, 2024	
<b>2</b>	<b>Technical Details</b>		
<b>(a)</b>	<b>Energy Input Details</b>		
(i)	Input Energy Purchase (From Generation Source)	Million kWh	382.45
(ii)	Net input energy (at DISCOM Periphery after adjusting the transmission losses and energy traded)	Million kWh	368.33
(iii)	Total Energy billed (is the Net energy billed, adjusted for energy traded))	Million kWh	299.18
<b>(b)</b>	Transmission and Distribution (T&D) loss Details	Million kWh	69.15
		%	18.77%
	Collection Efficiency	%	96%
<b>(c)</b>	Aggregate Technical & Commercial Loss	%	22%

The Distribution loss of 69.15 MU which is 18.77% of Net Input Energy at periphery and AT & C loss of 22 % is finalized for the FY 2023-2024 for EDA & N.





## 2 Background

---

### 2.1 Extant Regulations and Role of BEE

Bureau of Energy Efficiency (BEE) notified the Bureau of Energy Efficiency (Manner and Intervals for Conduct of Energy Audit (Accounting) in Electricity Distribution Companies) Regulations, 2021 on 6th October 2021. As per the regulation, all Electricity Distribution Companies are mandated to conduct annual energy audit and periodic energy accounting on quarterly basis.

Owing to the impact of energy auditing on the entire distribution and retail supply business and absence of an existing framework with dedicated focus on the same, it was imperative to develop a set of comprehensive guidelines that all Distribution utilities across India can follow and adhere to.

These Regulations for Energy audit in Electricity Distribution Companies provides broad framework for conduct of Annual Energy Audit though and Quarterly Periodic Energy Accounting with necessary Pre-requisites and reporting requirements to be met.

The extant regulations relevant or reproduced as under,

#### **A. Pre-requisites for annual energy audit and periodic energy accounting:**

every electricity distribution company shall undertake all actions as may be required for the annual energy audit and periodic energy accounting before the start of the relevant financial year, including the following actions, namely: —

- I. The identification and mapping of all of the electrical network assets;
- II. The identification and mapping of high tension and low-tension consumers;
- III. The development and implementation of information technology enabled energy accounting and audit system, including associated software;
- IV. The electricity distribution company shall ensure the installation of functional meters for all consumers, transformers and feeders: Provided that meter installation may be done in a phased manner within a period of three financial years from the date of the commencement of these regulations in accordance with the trajectory Set out in the First Schedule;
- V. All distribution transformers (other than high voltage distribution system up to 25KVA and other distribution system below 25 KVA) shall be metered with





## Annual Energy Audit of EDA&N FY 2023-24

communicable meters. And existing non communicable distribution transformer meters shall be replaced with communicable meters and integrated with advanced metering infrastructure;

VI. The electricity distribution company shall establish an information technology enabled system to create energy accounting reports without any manual interference: Provided that such system may be established—

- i. Within a period of three years from the date of the commencement of these regulations in case of urban and priority area consumers; and
- ii. Within five years from the date of the commencement of these regulations in case of rural consumers;

VII. The electricity distribution company shall create a centralized energy accounting and audit cell comprising of—

- a nodal officer, an energy manager and an information technology manager, having professional experience of not less than five years; and
- a financial manager having professional experience of not less than five years;

VIII. Any other requisite that Bureau may direct for energy audit and accounting purpose.

### **B. Reporting requirements for annual energy audit and periodic energy accounting:**

- I. Every electricity distribution company shall designate a nodal officer, who shall be a full-time employee of the electricity distribution company in the rank of the Chief Engineer or above, for the purpose of reporting of the annual energy audit and periodic energy accounting and communicate the same to the Bureau. Every electricity distribution company shall ensure that the energy accounting data is generated from a metering system or till such time the metering system is not in place, by an agreed method of assumption as may be prescribed by the State Commission.
- II. Metering of distribution transformers at High Voltage Distribution System up to 25KVA can be done on cluster meter installed by each electricity distribution company.





## Annual Energy Audit of EDA&N FY 2023-24

- III. Metering of distribution transformers at High Voltage Distribution System up to 25KVA can be done on cluster meter installed by each electricity distribution company.
- IV. Every electricity distribution company shall provide the details of the information technology system in place as specified in clause (f) of regulation 5 that ensures minimal manual intervention in creating the energy accounting reports and any manual intervention of any nature, in respect of the period specified therein, shall be clearly indicated in the periodic energy accounting report.

### **C. Manner of annual energy audit and periodic energy accounting:**

- I. Every annual energy audit and periodic energy accounting under these regulations shall be conducted in the following manner, namely: —
- II. Verification of existing pattern of energy distribution across periphery of electricity distribution company; and
- III. Verification of accounted energy flow submitted by electricity distribution company at all applicable voltage levels of the distribution network:
  - Energy flow between transmission and 66kV/33kV/11kV incoming distribution feeders;
  - Energy flow between 66kV/33kV outgoing and 11kV/6.6kV incoming feeders;
  - Energy flow between 11 kV/6.6kV feeders and distribution transformers, or high voltage distribution system;
  - Energy flow between distribution transformer, or high voltage distribution system to end consumer, including ring main system;
  - Energy flow between Feeder to end-consumer; and
  - Energy flow between 66/33/11 kV directly to consumer.
- IV. The accredited energy auditor, in consultation with the nodal officer of the electricity distribution company shall:
  - Develop a scope of work for the conduct of energy audit required under these regulations;
  - Agree on best practice procedures on accounting of energy distributed across the network; and





## Annual Energy Audit of EDA&N FY 2023-24

- Collect data on energy received, and distributed, covered within the scope of energy audit.

### V. The accredited energy auditor shall:

- Verify the accuracy of the data collected in consultation with the nodal officer of the electricity distribution companies as per standard practice to assess the validity of the data collected; and
- Analyze and process the data with respect to:
  - ✓ Consistency of data monitoring compared to the collected data;
  - ✓ Recommendations to facilitate energy accounting and improve energy efficiency.
  - ✓ With respect to the purpose of energy accounting in reducing losses for the electricity distribution company.

## 2.2 Role of BEE

- To develop policies and programs on efficient use of energy and its conservation with the involvement of stakeholders.
- To plan, manage and implement energy conservation programs as envisaged in the EC Act.
- To assume leadership and provide policy framework and direction to national energy efficiency and conservation efforts and programs.
- To demonstrate energy efficiency delivery mechanisms, as envisaged in the EC Act, through Private-Public Partnership (PPP).
- To establish systems and procedures to measure, monitor and verify energy efficiency results in individual sectors as well as at the national level.
- To leverage multi-lateral, bi-lateral and private sector support in implementation of programs and projects on efficient use of energy and its conservation.
- To promote awareness of energy savings and energy conservation.





## 2.3 Purpose of Audit and Accounting Report

Owing to the impact of energy auditing on the entire distribution and retail supply business and absence of an existing framework with dedicated focus on the same, it was imperative to develop a set of comprehensive guidelines that all Distribution utilities across India can follow and adhere to.

## 2.4 Period of Energy Auditing and Accounting

Bureau of Energy Efficiency (BEE) through Ministry of Power, Government of India issued regulations for Conduct of Mandatory Annual Energy Audit and Periodic Energy Accounting in DISCOMs. As per the regulation, all Electricity Distribution Companies are mandated to conduct annual energy audit and periodic energy accounting on quarterly basis.

Regulations on Manner and Intervals for Conduct of Energy Audit and Accounting in Electricity Distribution Companies has been framed. Energy Accounting means accounting of all energy inflows at various voltage levels in the distribution periphery of the network, including renewable energy generation and open access consumers, and energy consumption by the end consumers. Energy accounting and a consequent annual energy audit would help to identify areas of high loss and pilferage, and thereafter focus efforts to take corrective action.

These Regulations for Energy audit in Electricity Distribution Companies provides broad framework for conduct of Annual Energy Audit though and Quarterly Periodic Energy Accounting with necessary Pre-requisites and reporting requirements to be met







### 3 Discom Introduction & Overview

#### 3.1 Name and Address of DISCOM

**Name of the Designated Consumer:** The Electricity Department of Andaman & Nicobar Administration

**Address:** Vidyut Bhawan, Phoenix Bay, South Andaman, Sri Vijaya Puram- 744101

#### 3.2 Name and Contact Details of Energy Manager and Authorised Signatory of DISCOM (Nodal Officer)

Table 7 Details of Energy Manager and Authorized Signatory of DC

Details of Authorized Signatory	Details of Energy Manager
Hema Devi	Not Appointed/ Designated.
Nodal Officer, AE , PL-II	Mobile No:
Contact No - 03192-232404	Email:

#### 3.3 Summary Profile of EDA&N

##### 3.1.1 ASSETS

EDA&N has a vast infrastructure facility in its operating area with the following infrastructure details:

Table 8 Infrastructure Details

Sr.No	Particulars	As on 22 <sup>nd</sup> September 2024
1	Number of circles	1
2	Number of divisions	7
3	Number of sub-divisions	33
4	Number of feeders	65
5	No of 33/11 KV Substations	NA
6	Length of 33 KV line (KM)	590.165
7	Length of 11 KV line (KM)	895.072
8	Length of Low-tension line (KM)	3816.796
9	Length of Aerial Bunched Cables	935.525
10	Length of Underground Cables	311.655
11	Number of Distribution Transformers	1082
12	Connected load (MW)	154731

The HT by LT Ratio is 0.38 only which is very good, but transformation loss is high due to underloading of the transformers. On an average, the connected DTR capacity of 250 kVA has peak the load of 100 kVA. The power factor of the system is near about 0.88 at consumer end which contributes to the loss further.





## Annual Energy Audit of EDA&N FY 2023-24

### 3.1.2 ENERGY FLOW

The energy flow of EDA&N is presented in the following table:

**Table 9 Energy Flow of EDA&N**

Sr.No	Energy Flow Details	Unit	Value (2023-24)
1	Input Energy Purchase (From Generation Source)	Million kwh	382.45
2	Net input energy (at DISCOM Periphery after adjusting the transmission losses and energy traded)	Million kwh	368.33
3	Total Energy billed (is the Net energy billed, adjusted for energy traded))	Million kwh	299.18
4	Transmission and Distribution (T&D) loss Details	Million kwh	69.15
		%	18.77%
5	Collection Efficiency	%	96%
6	Aggregate Technical & Commercial Loss	%	22%



## Energy Flow Diagram of EDA&N for FY 2023-24

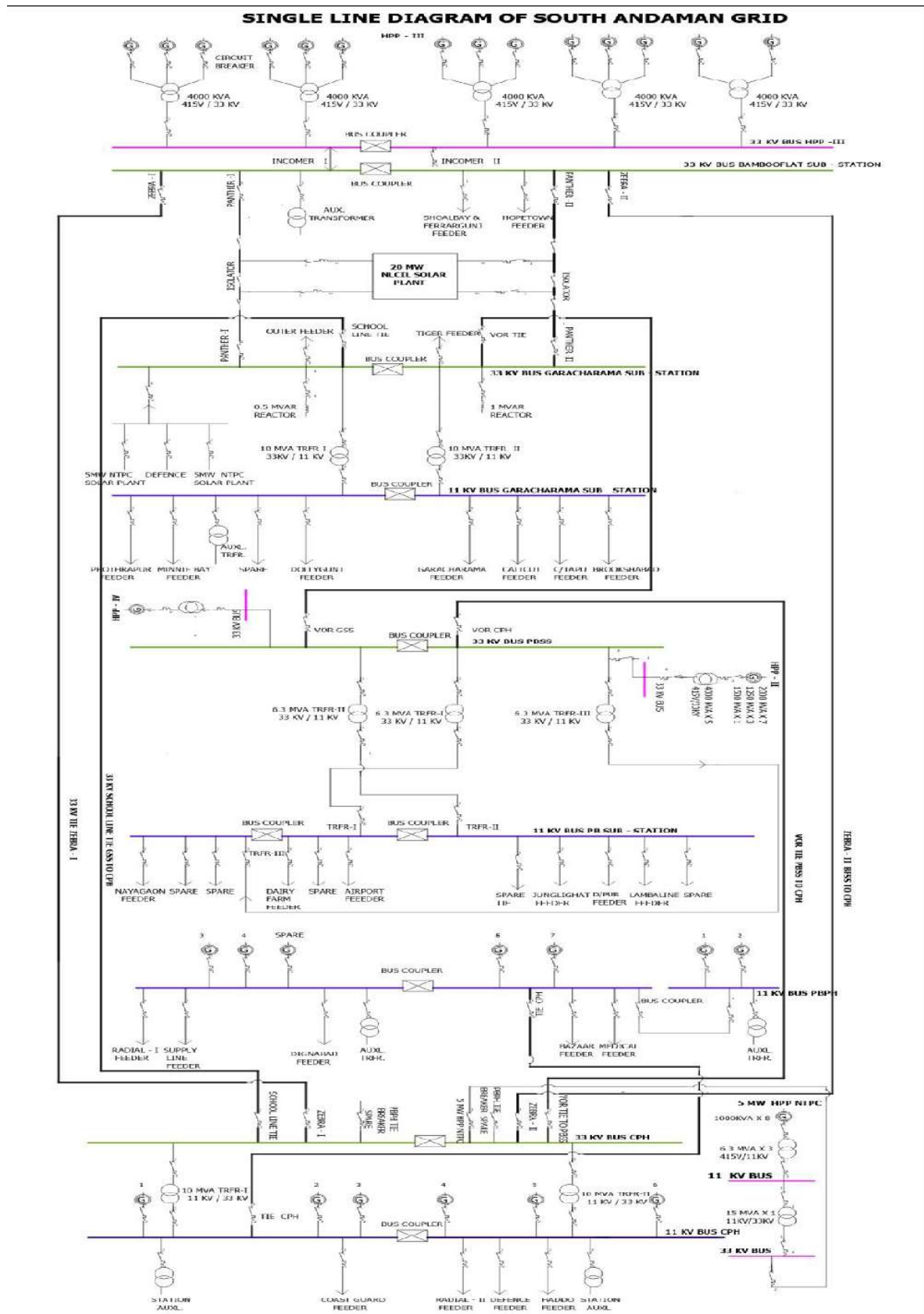



Annual Energy Audit of EDA&N FY 2023-24

CONSUMER BASE

EDA&N is supplying power to 154731 number of consumers as on 22nd September 2024.

The details of category wise consumers are presented in the following table:

Table 10 Category wise Consumer Details

Type of Consumers	Number of Consumers as on 22 <sup>nd</sup> September 2024
Residential	129580
Agricultural	667
Commercial/Industrial-LT	21525
Commercial/Industrial-HT	0
Others	2959
<b>Total</b>	<b>154731</b>

The metering status at different voltage levels of EDA&N consumers is presented below:

Table 11 Metering Status at different Voltage Levels

Sr. No	Parameters	66kV and above	33kV	11/22kV	LT
1	Number of conventional metered consumers	-	-	-	
2	Number of consumers with 'smart' meters	-	-	-	76000
3	Number of consumers with 'smart prepaid' meters	-	-	-	0
4	Number of consumers with 'AMR' meters	-	-	-	0
5	Number of consumers with 'non-smart prepaid' meters	-	-	-	86000
6	Number of unmetered consumers	-	-	-	0
	Number of total consumers	-	-	-	154731

3.1.3 Energy Flow details

Energy flow details for FY 2023-24 are given in the below table:

Sr.No	Parameter	Value
1	Input Energy purchased (MU)	382.45
2	Transmission loss (%)	4%
3	Transmission loss (MU)	15.29
4	Energy sold outside the periphery(MU)	299.18
5	Open Access Sale(MU)	0.00
	EHT sale	0.00
6	Net input energy (received at DISCOM periphery or at distribution point)-(MU)	368.33
7	Total metered sales	299.18
8	Total un-metered sales	0.00





Annual Energy Audit of EDA&N FY 2023-24

9	Total sales	299.18
10	Distribution losses	69.14
11	Distribution losses %	19%

Note-Open Access Sale Zero (0) since island it is not connected to grid.

3.1.4 Consumer Details

Energy consumption with type of customer is given in the table:

**Table 12: Customer Profile for FY 2023-24**

Category	No. of Connections		Connected Load		Energy Billed		Billed Amount	Collected Amount
	Nos	%	MW	%	MU	%	Rs. Crore	Rs. Crore
Residential	129580	84%	240.141	60%	168.10	56%	73.5156	70.518
Agricultural	667	0%	1.5291	0%	1.696	1%	0.5018	0.3179
Commercial/ Industrial-LT	21525	14%	105.470	27%	68.340	23%	91.870	85.499
Commercial/ Industrial-HT	0	0%	0	0%	0	0%	0	0
Others	2959	2%	50.364	13%	61.038	20%	90.856	89.796
<b>Total</b>	<b>154731</b>	<b>100 %</b>	<b>397.505</b>	<b>100%</b>	<b>299.18</b>	<b>100%</b>	<b>256.744</b>	<b>246.132</b>

3.1.5 Metering details

The status of meters installed in EDA & N as on 22-09-2024 are given in the below tables:

**Table 13: Voltage wise Meter Consumers**

Parameters	66kV and above	33kV	11/22kV	LT
Number of conventional metered consumers				
Number of consumers with 'smart' meters	0	0	0	76000
Number of consumers with 'smart prepaid' meters	0	0	0	0
Number of consumers with 'AMR' meters	0	0	0	0
Number of consumers with 'non-smart prepaid' meters	0	0	0	86000
Number of unmetered consumers	0	0	0	0
Number of total consumers				154731



## Annual Energy Audit of EDA&N FY 2023-24

### 3.1.6 Distribution Transformer (DT) details

The details of distribution transformers in EDA & N as on 22-09-2024 are given in the below tables:

**Table 14: Numbers of Distribution Transformers**

Parameters	66kV and above	33kV	11/22kV	LT
Number of conventionally metered Distribution Transformers	0	0	0	0
Number of DTs with communicable meters	0	0	0	0
Number of unmetered DTs	0	4	1	0
Number of total Transformers	0	0	0	1109

### 3.1.7 Feeder details

The details of feeder's in EDA & N as on 22-09-2024 are given in the below tables:

**Table 15: Voltage wise numbers of Feeders**

Parameters	66kV and above	33kV	11/22kV	LT
Number of metered feeders	-	11	46	4
Number of feeders with communicable meters	-	-	-	-
Number of unmetered feeders	-	-	4	-
Number of total feeders	-	11	50	4

### 3.1.8 Distribution Line details

The details of distribution lines in EDA & N as on 22-09-2024 are given in the below tables:

**Table 16: Length of Distribution Lines**

Parameters	66kV and above	33kV	11/22kV	LT
Line length(ctkm)	-	590.165	895.072	3816.796
Length of Aerial Bunched Cables	-	33.844	175.916	725.765
Length of Underground Cables	-	79.71	77.912	154.033

### 3.1.9 SALIENT FEATURES

- The EDA&N Teams being a union territory, 56% consumption is of residential consumers, 23% consumption is from commercial and Industrial LT consumers. Only 0.00% consumption is from commercial and Industrial HT consumers, 20% is from others consumers & 1% is from Agricultural consumers.



### 3.4 Energy Conservation Measures Already Taken and Proposed for Future

The root cause of data loss for feeder-wise loss analysis remains undetermined. Field assessments suggest replacing old oil-filled transformers, especially underloaded HVDS, with Star-rated distribution transformers. Feeder-wise metering and AMR implementation will be aligned with regulatory standards. Quarterly and feeder-wise energy audit reports will be maintained to enable granular analysis of distribution losses.

To improve voltage profile and reliability, Distribution Transformers (DTRs) were installed. This, however, has led to underutilization of the DTRs. To enhance system efficiency and minimize losses, the deployment of HVDS systems is proposed.





## 4 Energy Flow Analysis

### 4.1 Energy Flow across Service levels:

	Voltage level	Energy Sales Particulars	MU
i	LT Level	DISCOM' consumers	299
		Demand from open access, captive	0.00
		Embedded generation used at LT level	0.00
		Sale at LT level	299
		Quantum of LT level losses	69
		Energy Input at LT level	368
ii	11 kV Level	DISCOM' consumers	0.00
		Demand from open access, captive	0.00
		Embedded generation at 11 kV level used	
		Sales at 11 kV level	0.00
		Quantum of Losses at 11 kV	0.00
		Energy input at 11 kV level	0.00
iii	33 kV Level	DISCOM' consumers	
		Demand from open access, captive	
		Embedded generation at 33 kV or below level	
		Sales at 33 kV level	0.00
		Quantum of Losses at 33 kV	0.00
		Energy input at 33kV Level	
iv	> 33 kV	DISCOM' consumers	
		Demand from open access, captive	
		Cross border sale of energy	
		Sale to other DISCOMs	
		Banking	
		Energy input at > 33kV Level	
		Sales at 66kV and above (EHV)	0.00
<b>Total Energy Requirement</b>			<b>368</b>
<b>Total Energy Sales</b>			<b>299</b>







## 4.2 Validation of metered data

Energy details submitted to BEE by EDA & N have been verified from the various systems deployed at EDA & N. The Metered data visit (Meter Sl. Number, Meter reading date and the Multiplying Factor) is crossed checked during field. The 11kV feeder meters reading is validated during the Site visit. 66kV feeder are metered at 220/66 kV substation and also at 66kV consumers.

### 4.1.1. Schedule of the work for Metered data validation

Initial kick of meeting was arranged between the EDA & N official and the PPSES Team on 22<sup>nd</sup> September 2024. In the kick of meeting the various data, PPSES team raised gaps.

EDA & N officials responded to the data gaps and the plan for the site visit with Accredited Energy Auditor was prepared.

The field visits were conducted on 22<sup>nd</sup> September 2024. The schedule of the visits is as follows.

Table 17 Schedule of the Work

Date	Places Visited	Information validated	Remarks
22 <sup>nd</sup> September 2024	Office of EDA & N	Meeting with AEA Team and the team of EDA & N on report finalization for Year 2023-24.	EDA & N Submitted the Energy Audit data which was submitted to BEE FY 2023-2024.
22 <sup>nd</sup> September 2024	Ho of EDA & N Discom	The physical verification of the meters at the Substation and the Consumer end meters were carried out and same were matched with the data base for sample consumers.	The field information was found to be consistent with the information in the software systems. 11kV Bazaar Feeder feet Survey
23 September 2024	Chatham	Phoenix Bay and Chatham data monitoring Centere	Panel meters and 33kV feeder meters
23 September 2024	North Andaman	Diglipur Consumer and Substation North Andaman	Consumer meters verified and Susbtation meters
24 September 2024	Maya Bunder	Maya Bunder Consumer data verification	Consumer meters verified and Susbtation meters



Annual Energy Audit of EDA&N FY 2023-24

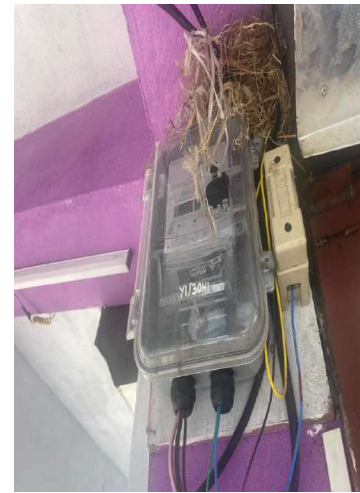

Old Analog Meter

Government Consumer Meter's

# Annual Energy Audit of EDA&N FY 2023-24

STATE OF PUNJAB, ELECTRICITY DEPARTMENT, POWER ADMINISTRATION, CHANDIGARH

LAUNCH NO. \_\_\_\_\_ DATE \_\_\_\_\_

NAME OF THE UNIT \_\_\_\_\_

Sl. No.	Particulars	Unit	Month														
			Jan	Feb	Mar	Apr	May	Jun	Jul	Aug	Sep	Oct	Nov	Dec			
1	Electricity consumed	kWh															
2	Water consumed	m <sup>3</sup>															
3	Gas consumed	cu m															
4	Coal consumed	MT															
5	Oil consumed	MT															
6	Other fuel consumed																
7	Total																

STATE OF PUNJAB, ELECTRICITY DEPARTMENT, POWER ADMINISTRATION, CHANDIGARH

LAUNCH NO. \_\_\_\_\_ DATE \_\_\_\_\_

NAME OF THE UNIT \_\_\_\_\_

Sl. No.	Particulars	Unit	Month														
			Jan	Feb	Mar	Apr	May	Jun	Jul	Aug	Sep	Oct	Nov	Dec			
1	Electricity consumed	kWh															
2	Water consumed	m <sup>3</sup>															
3	Gas consumed	cu m															
4	Coal consumed	MT															
5	Oil consumed	MT															
6	Other fuel consumed																
7	Total																

Yearly Form Report on A/Cs

Sl. No. / Name of the A/C

Capacity (TR)

Power (kW)

Energy consumed (kWh)

Cost (₹)

Remarks

Sl. No.	Name of the A/C	Capacity (TR)	Power (kW)	Energy consumed (kWh)	Cost (₹)	Remarks
1	...	...	...	...	...	...
2	...	...	...	...	...	...
3	...	...	...	...	...	...
4	...	...	...	...	...	...
5	...	...	...	...	...	...
6	...	...	...	...	...	...
7	...	...	...	...	...	...
8	...	...	...	...	...	...
9	...	...	...	...	...	...
10	...	...	...	...	...	...
11	...	...	...	...	...	...
12	...	...	...	...	...	...
13	...	...	...	...	...	...
14	...	...	...	...	...	...
15	...	...	...	...	...	...
16	...	...	...	...	...	...
17	...	...	...	...	...	...
18	...	...	...	...	...	...
19	...	...	...	...	...	...
20	...	...	...	...	...	...
21	...	...	...	...	...	...
22	...	...	...	...	...	...
23	...	...	...	...	...	...
24	...	...	...	...	...	...
25	...	...	...	...	...	...
26	...	...	...	...	...	...
27	...	...	...	...	...	...
28	...	...	...	...	...	...
29	...	...	...	...	...	...
30	...	...	...	...	...	...
31	...	...	...	...	...	...
32	...	...	...	...	...	...
33	...	...	...	...	...	...
34	...	...	...	...	...	...
35	...	...	...	...	...	...
36	...	...	...	...	...	...
37	...	...	...	...	...	...
38	...	...	...	...	...	...
39	...	...	...	...	...	...
40	...	...	...	...	...	...
41	...	...	...	...	...	...
42	...	...	...	...	...	...
43	...	...	...	...	...	...
44	...	...	...	...	...	...
45	...	...	...	...	...	...
46	...	...	...	...	...	...
47	...	...	...	...	...	...
48	...	...	...	...	...	...
49	...	...	...	...	...	...
50	...	...	...	...	...	...
51	...	...	...	...	...	...
52	...	...	...	...	...	...
53	...	...	...	...	...	...
54	...	...	...	...	...	...
55	...	...	...	...	...	...
56	...	...	...	...	...	...
57	...	...	...	...	...	...
58	...	...	...	...	...	...
59	...	...	...	...	...	...
60	...	...	...	...	...	...
61	...	...	...	...	...	...
62	...	...	...	...	...	...
63	...	...	...	...	...	...
64	...	...	...	...	...	...
65	...	...	...	...	...	...
66	...	...	...	...	...	...
67	...	...	...	...	...	...
68	...	...	...	...	...	...
69	...	...	...	...	...	...
70	...	...	...	...	...	...
71	...	...	...	...	...	...
72	...	...	...	...	...	...
73	...	...	...	...	...	...
74	...	...	...	...	...	...
75	...	...	...	...	...	...
76	...	...	...	...	...	...
77	...	...	...	...	...	...
78	...	...	...	...	...	...
79	...	...	...	...	...	...
80	...	...	...	...	...	...
81	...	...	...	...	...	...
82	...	...	...	...	...	...
83	...	...	...	...	...	...
84	...	...	...	...	...	...
85	...	...	...	...	...	...
86	...	...	...	...	...	...
87	...	...	...	...	...	...
88	...	...	...	...	...	...
89	...	...	...	...	...	...
90	...	...	...	...	...	...
91	...	...	...	...	...	...
92	...	...	...	...	...	...
93	...	...	...	...	...	...
94	...	...	...	...	...	...
95	...	...	...	...	...	...
96	...	...	...	...	...	...
97	...	...	...	...	...	...
98	...	...	...	...	...	...
99	...	...	...	...	...	...
100	...	...	...	...	...	...

STATE OF PUNJAB, ELECTRICITY DEPARTMENT, POWER ADMINISTRATION, CHANDIGARH

LAUNCH NO. \_\_\_\_\_ DATE \_\_\_\_\_

NAME OF THE UNIT \_\_\_\_\_

Sl. No.	Particulars	Unit	Month														
			Jan	Feb	Mar	Apr	May	Jun	Jul	Aug	Sep	Oct	Nov	Dec			
1	Electricity consumed	kWh															
2	Water consumed	m <sup>3</sup>															
3	Gas consumed	cu m															
4	Coal consumed	MT															
5	Oil consumed	MT															
6	Other fuel consumed																
7	Total																

STATE OF PUNJAB, ELECTRICITY DEPARTMENT, POWER ADMINISTRATION, CHANDIGARH

LAUNCH NO. \_\_\_\_\_ DATE \_\_\_\_\_

NAME OF THE UNIT \_\_\_\_\_

Sl. No.	Particulars	Unit	Month														
			Jan	Feb	Mar	Apr	May	Jun	Jul	Aug	Sep	Oct	Nov	Dec			
1	Electricity consumed	kWh															
2	Water consumed	m <sup>3</sup>															
3	Gas consumed	cu m															
4	Coal consumed	MT															
5	Oil consumed	MT															
6	Other fuel consumed																
7	Total																

STATE OF PUNJAB, ELECTRICITY DEPARTMENT, POWER ADMINISTRATION, CHANDIGARH

LAUNCH NO. \_\_\_\_\_ DATE \_\_\_\_\_

NAME OF THE UNIT \_\_\_\_\_

Sl. No.	Particulars	Unit	Month														
			Jan	Feb	Mar	Apr	May	Jun	Jul	Aug	Sep	Oct	Nov	Dec			
1	Electricity consumed	kWh															
2	Water consumed	m <sup>3</sup>															
3	Gas consumed	cu m															
4	Coal consumed	MT															
5	Oil consumed	MT															
6	Other fuel consumed																
7	Total																

STATE OF PUNJAB, ELECTRICITY DEPARTMENT, POWER ADMINISTRATION, CHANDIGARH

LAUNCH NO. \_\_\_\_\_ DATE \_\_\_\_\_

NAME OF THE UNIT \_\_\_\_\_

Sl. No.	Particulars	Unit	Month														
			Jan	Feb	Mar	Apr	May	Jun	Jul	Aug	Sep	Oct	Nov	Dec			
1	Electricity consumed	kWh															
2	Water consumed	m <sup>3</sup>															
3	Gas consumed	cu m															
4	Coal consumed	MT															
5	Oil consumed	MT															
6	Other fuel consumed																
7	Total																





Annual Energy Audit of EDA&N FY 2023-24

4.1.2. Check list Prepared by EM/AEA

List of Documents

Sr. No	Description
1	Energy Purchase Documents- Power Purchase report from all sources
2	Consumers Category wise details
3	Billed energy for different category of the consumer
4	Annual Calculation of transmission Loss
5	Annual Sales Report
6	input and billed energy
7	Infrastructure details

4.2. Validation of Energy Flow Data & Losses:

Data Energy details submitted to BEE by EDA & N have been verified from the various systems deployed at EDA & N. Validation of Energy Flow & Losses for Division wise is tabulated below:

1) Losses for FY 2023-2024.

Consumer category	Input energy (MU)	Total Bill edenergy (MU)	T&D loss (MU)	T&D loss (%)	Billed Amount in Rs. Crore	Collected Amount in Rs. Crore	Collection Efficiency	AT & C loss (%)
Residential	368.33	168.10	69.14	19%	73.51	70.51	95.92%	22%
Agricultural		1.69			0.50	0.31	63.37%	
Commercial/ Industrial-LT		68.34			91.87	85.49	93.07%	
Commercial/ Industrial-HT		0			0	0.00%		
Others		61.03			90.85	89.79	98.83%	
<b>Total</b>	<b>368.33</b>	<b>299.18</b>	<b>69.14</b>	<b>19%</b>	<b>256.74</b>	<b>246.13</b>	<b>95.87%</b>	<b>22%</b>



## 5. Loss & Subsidy Computation

### 5.1. Energy Accounts of FY 2023-24

#### 5.1.1. Trend Analysis of EDA & N

Quarter NO.	Input Energy Purchase	Net Input Energy	Total Billed Energy	T & D Losses	T & D Losses	AT & C Losses
				In MU	In %	
Quarter 1	96.74	95.8	76.57	19.23	20.07	37
Quarter 2	82.99	82.99	73.41	9.58	11.54	6
Quarter 3	90.93	90.93	72.19	18.73	20.6	18
Quarter 4	98.43	98.43	77.04	21.38	21.72	25

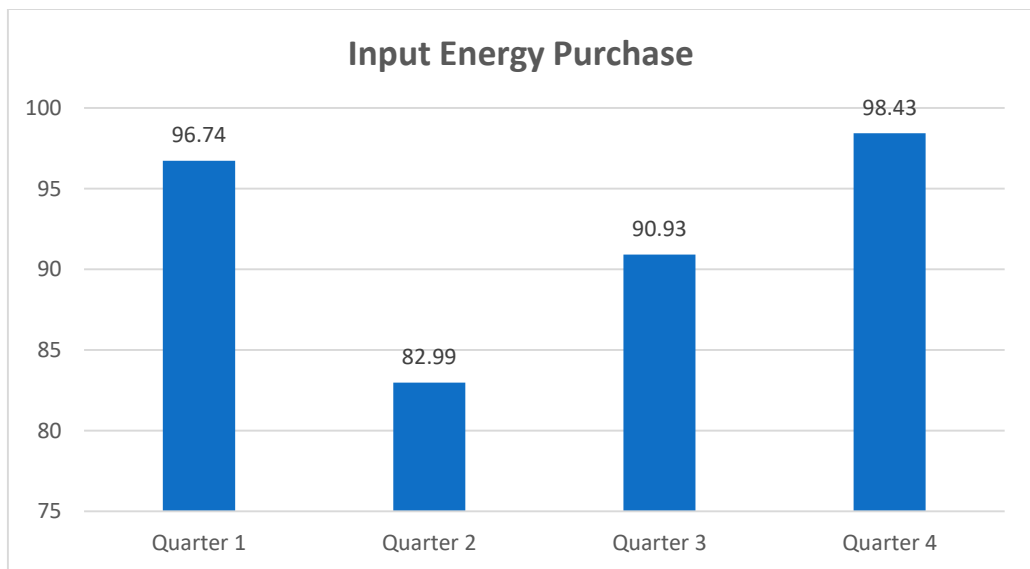

Figure 1 input energy Purchase in MU

Net Input Energy is Minimum for Q2 Quarter & Maximum for Q4 Quarter.



## Annual Energy Audit of EDA&N FY 2023-24

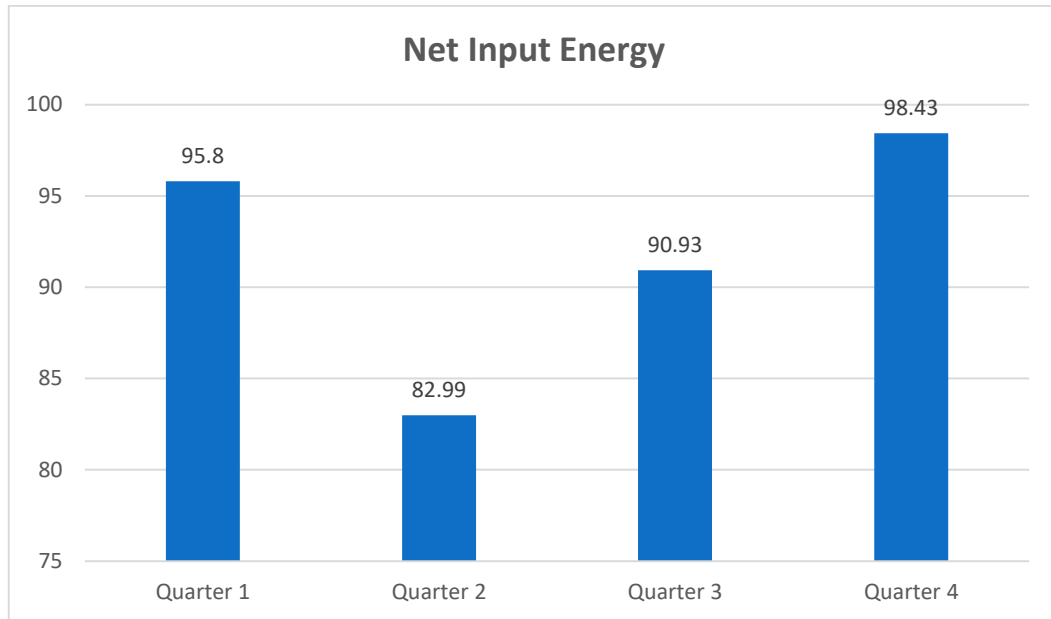

Figure 2 Net input energy in MU

Net Input Energy is Minimum for Q2 Quarter & Maximum for Q4 Quarter.

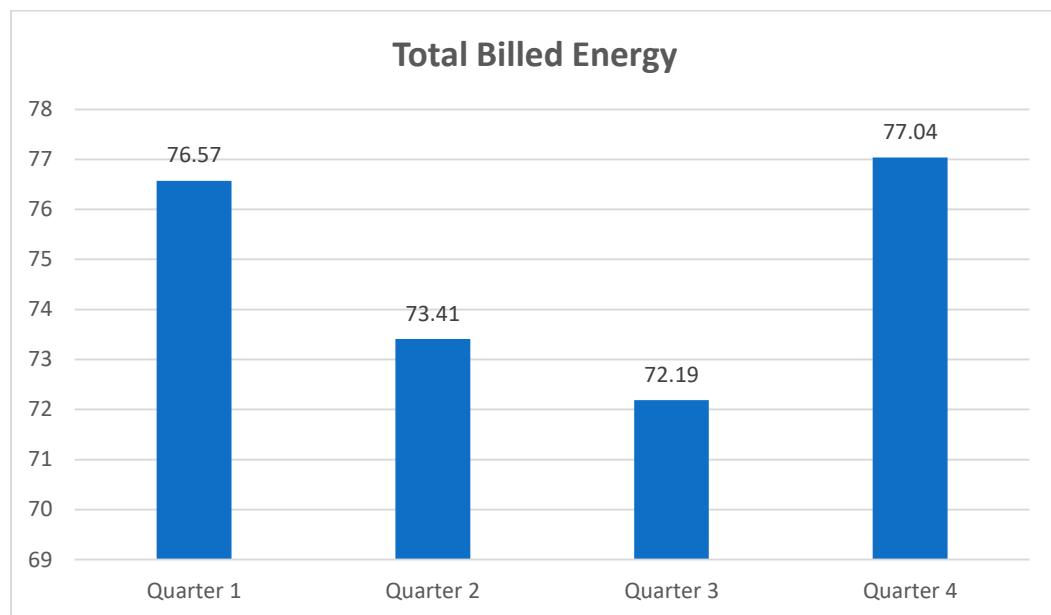

Figure 3 Total Energy billed in MU

Total Billed Energy is Minimum for Q3 Quarter & Maximum for Q4 Quarter



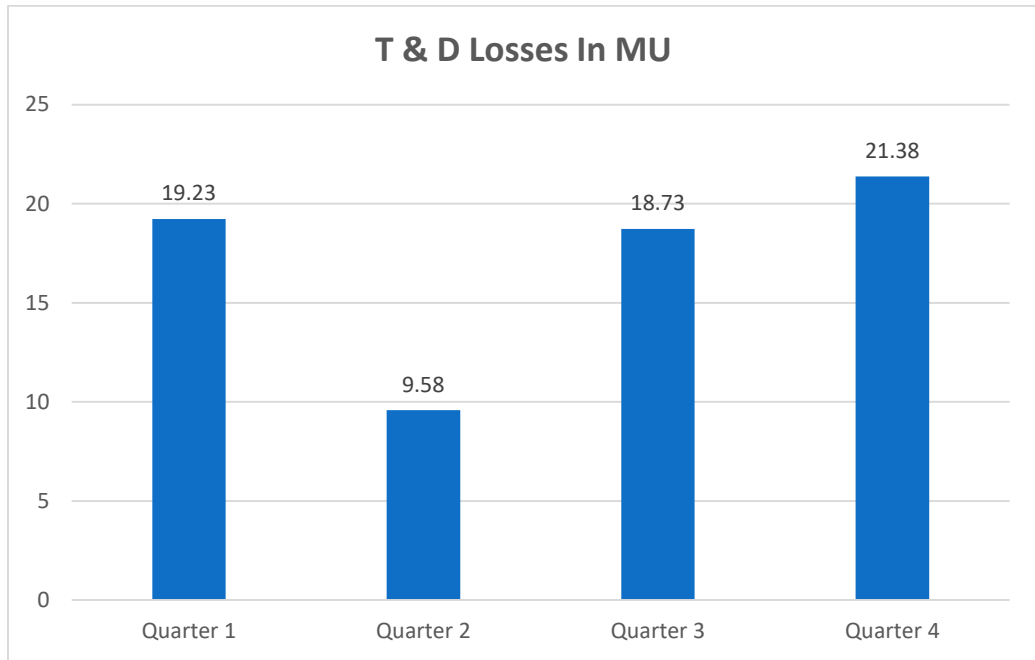

Figure 4 Transmission and Distribution (T&D) loss Details MU

Transmission and Distribution (T&D) loss Details MU is Minimum for Q2 Quarter & Maximum for Q4 Quarter.

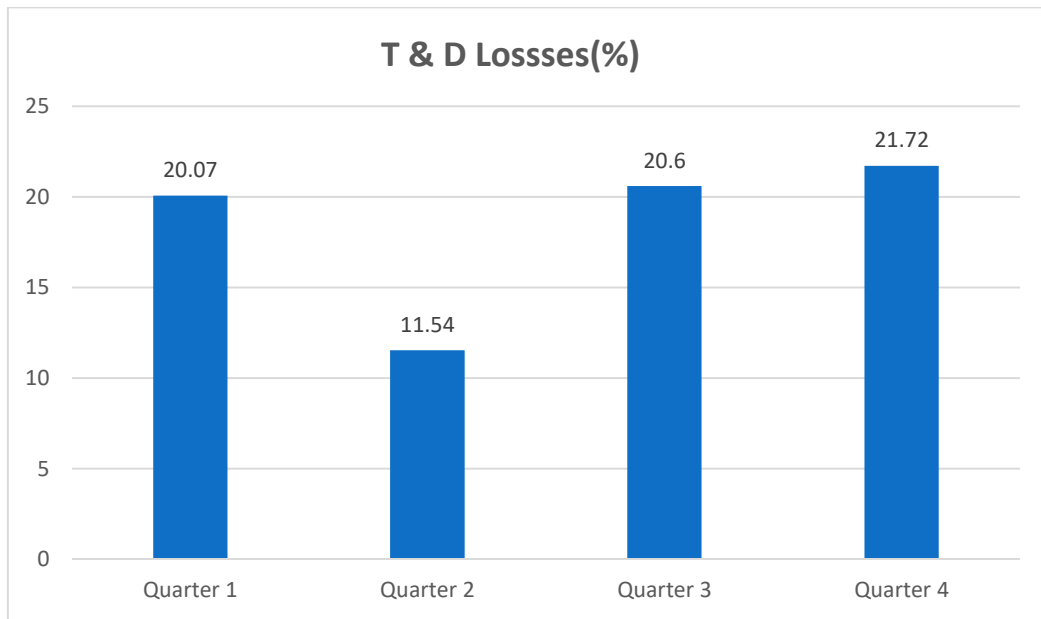

Figure 5 Transmission and Distribution (T&D) loss Details %

Transmission and Distribution (T&D) loss in % is Minimum for Q2 Quarter & Maximum for Q4 Quarter.

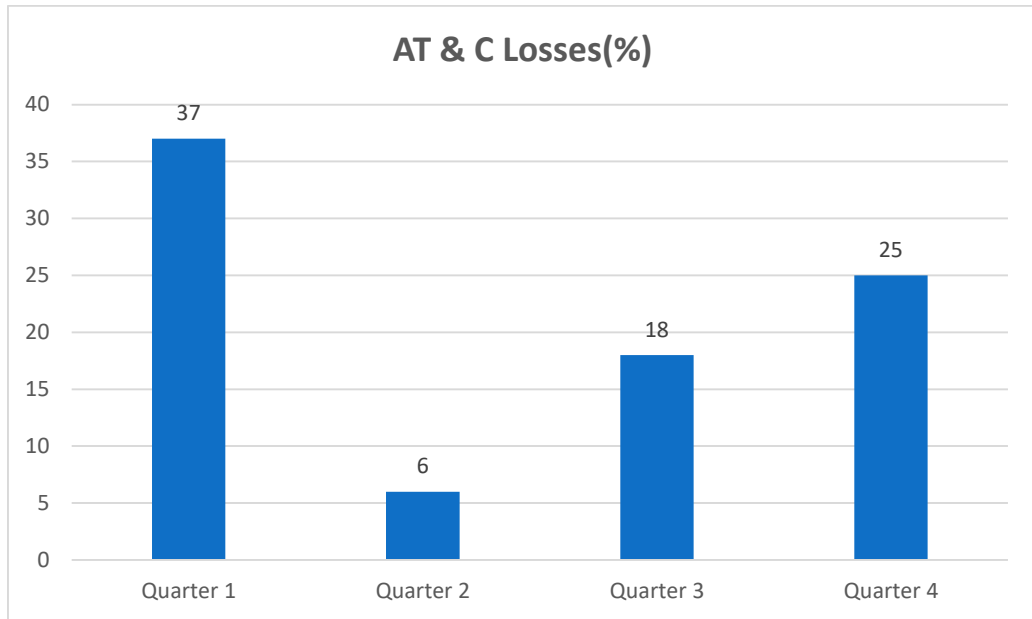

Figure 6 Aggregate Technical & Commercial Loss %

Aggregate Technical & Commercial Loss % is Minimum for Q2 Quarter & Maximum for Q1 Quarter.

## 5.2. Energy Accounts Analysis for Previous Year (FY 2022-23)

Sr. No.	Particulars	FY 2022-23
	<b>Energy Requirement</b>	-
1	Energy Sales	284
2	T&Distribution loss %	15.14%
3	T& Distribution loss	50.62
4	Energy Requirement	334

Table 18 Division Wise Losses

Division Wise Losses					
Sr.No	Name of circle	Name of Division FY 2023-24	FY 2022-23		
			T&D loss (MU)	T&D loss (%)	AT & C loss (%)
1	Sri Vijaya Puram	PG,HQ,NRSE, SA(PARTIAL)	22.91	12%	19%
2	South Andaman	South Andaman	12.26	17%	26%
3	RURAL	RURAL	6.72	22%	37%
4	NORTH ANDAMAN	NORTH ANDAMAN	5.41	25%	34%
5	NICOBAR	NICOBAR	3.30	19%	38%





Annual Energy Audit of EDA&N FY 2023-24

Parameters	FY 2022-23
T&D Loss	15.14%
Collection Efficiency	90%
AT&C Loss	24%
No. of metered consumer	149621
No. of un-metered consumer	0
No. of DT meters	NA
No. of un-metered DTs	NA
No. of metered feeders	65



### 5.3. Energy Accounts Analysis and Performance of FY 2023-24

#### 5.3.1. DISCOM Wide Energy Accounting

The net energy input to the EDA&N for FY 2023-2024 is estimated and presented in the following table.

**Table 19 Net Energy Input to EDA&N**

S. No.	Parameters	Period From 2023 To 2024
1	Net input energy (received at DISCOM periphery or at distribution point)-(MU)	382.45
2	T&D loss (%)	18.77
3	T&D loss (MU)	69.15
4	Energy sold outside the periphery (MU)	0.00
5	Open access sale (MU)	0.00
6	EHT sale	0.00

The technical losses and AT & C losses for FY 2023-24 are estimated and presented in the following table:

**Table 20 Summary of Losses of EDA&N**

Total Losses	T&D Loss		Collection Efficiency (%)	AT& C Loss (%)
	T&D Loss (MU)	T&D Loss (%)		
		69.15	18.77%	96%

The total sales (metered and assessed) for various consumer categories are presented in the following table:

**Table 21 Category wise Energy Account of EDA&N**

Sr. No	Type of Consumers	Category Of Consumers (EHT/HT/LT/Other)	Voltage Level (Voltage )	No of Consumers	Total Consumption (In MU)
1	Residential	-	-	129580	168.10
2	Agricultural	-	-	667	1.69
3	Commercial/Industrial- LT	LT	-	21525	68.34
4	Commercial/Industrial-HT	HT	-	0.00	0.00
5	Others	LT	-	2959	61.03
	<b>Total</b>			<b>154731</b>	<b>299.18</b>



Annual Energy Audit of EDA&N FY 2023-24

5.3.2. Division Wise Losses

The division wise T&D and AT&C losses for FY 2023-24 is tabulated below:

Table 22 Division wise Performance

Sr.No	Name of Division	Energy parameters				Losses	
			Billed energy (MU)			T&D loss (MU)	T&D loss (%)
		Input energy (MU)	Metered energy	Unmetered/assessment energy	Total energy		
1	PG HQ NRSE SA (PARTIAL)	217.81	178.92	0	178.92	38.88	18%
2	SOUTH ANDAMAN	77.74	63.45	0	63.445	14.29	18%
3	RURAL	32.26	25.45	0	25.44	6.811	21%
4	NORTH ANDAMAN	22.52	16.68	0	16.68	5.84	26%
5	NICOBAR	18.00	14.68	0	14.678	3.322	18%
	<b>Total</b>	<b>368.33</b>	<b>299.2</b>	<b>0</b>	<b>299.18</b>	<b>69.15</b>	<b>19%</b>





### 5.3.3. Voltage Wise Input and Losses

The voltage-wise analysis for the fiscal year 2023-24 in the EDA&N network cannot be compiled at present due to the absence of data. The energy balance calculations rely on the input energy and consumers' metered energy, rendering voltage-specific analysis unattainable for the specified period.

Also, the network is transferred to torrent power, due this the data for the feeder wise losses couldn't be accessed.

**Table 23 : Different Types of Meter connection in EDA & N**

	Parameters	66kV and above	33kV	11kV/22kV	LT
a.	Number of conventional metered consumers (Electronic Meters)	0	0	0	0
ii	Number of consumers with 'smart' meters	0	0	0	76000
iii	Number of consumers with 'smart prepaid' meters	0	0	0	0
iv	Number of consumers with 'AMR' meters	0	0	0	0
v	Number of consumers with 'non-smart prepaid' meters	0	0	0	86000
vi	Number of unmetered consumers	0	0	0	0
<b>vii</b>	<b>Number of total consumers</b>	<b>0</b>	<b>0</b>	<b>0</b>	<b>154731</b>





Annual Energy Audit of EDA&N FY 2023-24

5.3.4. Category wise Assessed loss of EDA & N

Table 24 : T & D loss category wise

Consumer category	Billed energy (MU)				% of energy consumption	T&D loss(MU)	T&D loss (%)			
	Input energy(MU)	Metered energy	Unmetered /assessment energy	Total energy						
Residential	368.33	168.11	0	168.10	56%	69.149	19%			
Agricultural		1.696	0	1.69	1%					
Commercial/Industrial-LT		68.34	0	68.34	23%					
Commercial/Industrial-HT		0.00	0	0.00	0%					
Others		61.03	0	61.03	20%					
<b>Total</b>		<b>368.33</b>	<b>299.18</b>	<b>0</b>	<b>299.18</b>			<b>100%</b>	<b>69.149</b>	<b>19%</b>

Table 25 : Category wise AT & C loss

Consumer category	Input energy(MU)	Total Billed Energy (MU)	Billed Amount in Rs. Crore	Collected Amount in Rs. Crore	Collection Efficiency	AT & C loss(%)
Residential	368.33	168.10	73.51	70.51852	95.92%	22%
Agricultural		1.696	0.501	0.3179851	63.37%	
Commercial/Industrial-LT		68.34	91.87	85.49984	93.07%	
Commercial/Industrial-HT		0	0	0	0.00%	
Others		61.03	90.85	89.7965	98.83%	
<b>Total</b>		<b>368.33</b>	<b>299.18</b>	<b>256.74</b>	<b>246.133</b>	



## Annual Energy Audit of EDA&N FY 2023-24

### 5.3.5. Feeder wise Assessed loss of EDA & N

The feeder wise energy audit is not yet carried out as the feeders Indexing is under process.

### 5.3.6. High loss feeder names of EDA & N

The feeder wise energy audit is not yet carried out as the feeders Indexing is under process.

## 5.4. Subsidy Computation and Analysis (based on quarterly data)

Data on the Subsidy is still being computed.

## 5.5. Trend Analysis of EDA & N

### 1) Maximum Recorded Demand for FY 2023-24

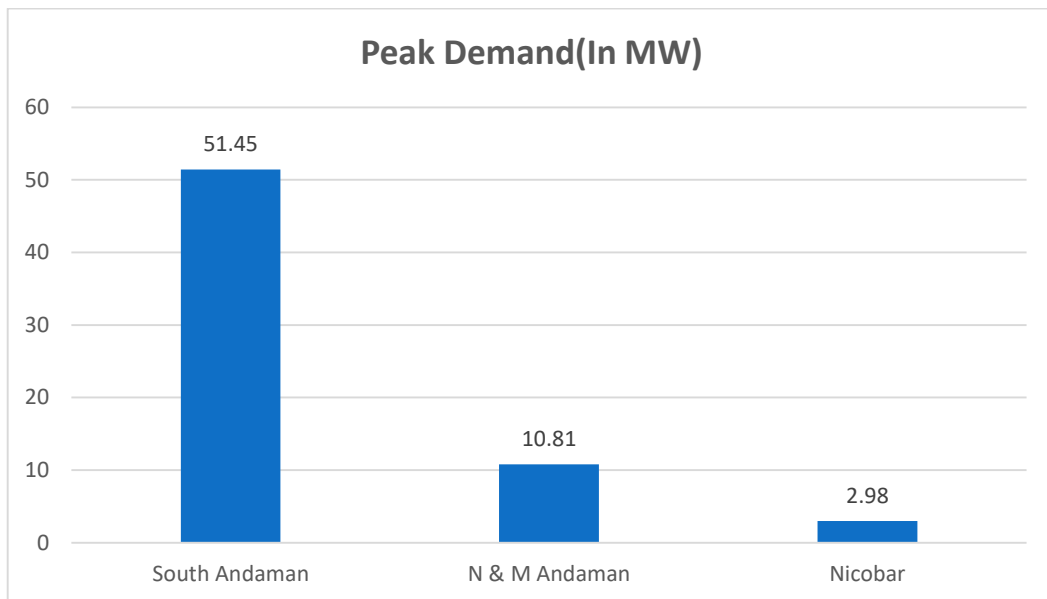

Peak demand of the Year 2023-24 was 51.45 MW in South Andaman.

## 6. Energy Audit Findings

---

### 6.1. Review of capacity of DISCOM's energy accounting and audit Cell-T

The team is yet to be formed as per regulation. The process of appointment of the Energy Manager is in the final stage.

The capacity of the staff need to be increased by training on the energy audit methodology.

Expert is required to be appointed in order to train the staff and continuous training and monitoring is required of the Audit cell.

### 6.2. Critical Analysis by Energy Auditor

The Andaman and Nicobar Islands are electrically isolated, with each island operating as an independent power system. The power supply on these islands is primarily sourced from diesel generator (DG) sets, supplemented by solar photovoltaic (PV) systems. The main island's power system is susceptible to grid instability, resulting in frequent system-wide outages even for localized faults. The distribution network in the headquarters division is configured as a radial system without a robust central grid infrastructure. Solar PV generation is inherently variable due to meteorological factors such as cloud cover and irradiance levels. Additionally, underloading conditions during peak solar generation periods can limit the system's ability to absorb excess power

The HT/LT transformation ratio of 0.38 is favorable, indicating efficient voltage transformation. However, the underutilization of distribution transformers (DTRs) is leading to increased transformer losses. On average, 250 kVA DTRs are operating at a peak load of only 60 kVA.

During FY 2023-24, the peak demand was recorded at 65 MW against a connected DTR capacity of 253 MW, resulting in a low system peak utilization of 23%. This overprovisioning of DTRs is due to voltage regulation concerns.

Since power is stepped up from LT to HT without adequate power factor correction, power factor issues and increased load angles are prevalent. This can lead to reduced power transmission capacity.

To mitigate these challenges, the following measures are recommended:

**Static VAR Compensation:** Deploying static VAR compensators at strategic locations can improve power factor and system voltage profile.

**Harmonic Filtering:** Implementing harmonic filters at appropriate locations can mitigate harmonic distortion and improve power quality.





Annual Energy Audit of EDA&N FY 2023-24

**Detailed System Studies:** Conduct comprehensive system studies to identify specific areas for improvement, including load flow analysis, short-circuit analysis, and harmonic analysis.

**Advanced Metering Infrastructure (AMI):** Implement AMI solutions to enable real-time monitoring of DTR loading, voltage profiles, and power quality parameters.

**Optimized DTR Sizing and Placement:** Conduct a thorough load study to optimize DTR capacity and placement, reducing unnecessary overprovisioning.

By implementing these measures, the distribution system can be made more efficient, reliable, and resilient.

### 6.3. Status of Various Compliance

Sr. No.	Particulars	Status
1	Quarterly reports for FY 2023-2024	Submitted to BEE
2	Yearly Pro-forma for year 2023-2024	Submitted to BEE with report

The following are observation based on the above the submission by EDA & N Team.

### 6.4. Pre-requisite of Annual Energy Audit of EDA & N:

Clause	Details	Sub-Clause	Criteria	Compliance Status
3	Intervals of time for conduct of annual energy audit.	a	Conducted an annual energy audit for every financial year and submitted the annual energy audit report to the Bureau and respective State. Designated Agency and also made available on the website of the electricity distribution company within a period of four months from the expiry of the relevant financial year	yes
4	Intervals of time for conduct of periodic energy accounting.	a	All feeder wise, circle wise and division wise periodic energy accounting is conducted by the energy manager of the electricity distribution company for each	No, EM is yet To be appointed







Annual Energy Audit of EDA&N FY 2023-24

Clause	Details	Sub-Clause	Criteria	Compliance Status
			quarter of the financial year.	
		b	Electricity distribution company conducted its first periodic energy accounting, for the last quarter of the financial year immediately preceding the date of such commencement (i.e., 6 <sup>th</sup> October 2021)	yes
		c	Electricity distribution company conducted its subsequent periodic energy accounting for each quarter of the financial year for a period of two financial years from the date of such commencement and submit the periodic energy accounting report within sixty days from the date of periodic energy accounting	yes
5	Pre-requisites for annual energy audit and periodic energy accounting.	a	Pre-requisites for annual energy audit and periodic energy accounting	yes
		b	Identification and mapping of high tension and low- tension consumers	yes
		c	Development and implementation of information technology enabled energy accounting and audit system, including associated software	The software for Meter Management Data is in progress & it will implement at the earliest.





Clause	Details	Sub-Clause	Criteria	Compliance Status
		d	Electricity distribution company ensures the installation of functional meters for all consumers, transformers and feeders. Meter installation is done in a phased manner within a period of three financial years from the date of the commencement of these regulations in accordance with the trajectory set out in the First Schedule	communicable meters are installed but the system for the monitorin is not yet implemented
		d.1.	100% Communicable Feeder Metering integrated with AMI, by 31st December 2022 along with replacement of existing non-communicable feeder meters.	
		d.2.	All Distribution Transformers (other than HVDS DT up to 25kVA and other DTs below 25 kVA) shall be metered with communicable meters. Communicable DT Metering for the following areas/ consumers to be completed by December 2023 and in balance areas by December 2025:	being done
		d.2.1.	All Electricity Divisions of 500 AMRUT cities, with AT&C Losses > 15%	Not applicable
		d.2.2.	All Union Territories (for areas with technical difficulty, non-communicable meters may be installed)	YES
		d.2.3.	All Industrial and Commercial consumers	yes
		d.2.4.	All Government offices at Block level and above	yes



Clause	Details	Sub-Clause	Criteria	Compliance Status
			d.2.5. Other high loss areas i.e., rural areas with losses more than 25% and urban areas with losses more than 15%	Metering is being implemented
			d.3. Prepaid Smart Consumer Metering to be completed for all directly connected meters and AMR in case of other meters, by December 2023 in the following areas:	No
			d.3.1. All Electricity Divisions of 500 AMRUT cities, with AT&C Losses > 15%;	
			d.3.2. All Union Territories (for areas with technical difficulty, prepaid meters to be installed);	YES
			d.3.3. All Industrial and Commercial consumers;	YES
			d.3.4. All Government offices at Block level and above;	yes
			d.3.5. Other high loss areas i.e., rural areas with losses more than 25% and urban areas with losses more than 15%.	YES
			d.4. Consumer Metering: 98% by FY 2022-23 & 99% by FY 2023-24	100%
			d.5. Targets for functional meters - For FY 22-23, FY 23-24 & FY24-25 Feeder metering 98.5%, 99.5% & 99.5% DT metering 90%, 95% & 98% Consumer metering 93%,96% & 98	DT metering work is in progress.
		e	e.1. All distribution transformers (other than high voltage distribution system up to 25kVA and other distribution system below 25	Metered



Clause	Details	Sub-Clause	Criteria	Compliance Status
			kVA) is metered with communicable meters.	
			e.2. And existing non communicable distribution transformer meters is replaced with communicable meters and integrated with advanced metering infrastructure.	being done
		f	Electricity distribution company has established an information technology enabled system to create energy accounting reports without any manual interference and such systems may be within a period of three years from the date of the commencement of these regulations in case of urban and priority area consumers; and within five years from the date of the commencement of these regulations in case of rural consumers	EMS is software used for billing, The software for Meter Management Data is in progress & it will implement at the earliest.
		g	Electricity distribution company has a centralized energy accounting and audit cell comprising of	yes
			(i) a nodal officer, an energy manager and an information technology manager, having professional experience of not less than five years; and	
			(ii) a financial manager having professional experience of not less than five years	



Annual Energy Audit of EDA&N FY 2023-24

Clause	Details	Sub-Clause	Criteria	Compliance Status
6	Reporting requirements for annual energy audit and periodic energy accounting	a	Electricity distribution company has a nodal officer, who is a full-time employee of the electricity distribution company in the rank of the Chief Engineer or above, for the purpose of reporting of the annual energy audit and periodic energy accounting and communicate the same to the Bureau	Chief Engineer-Customer Care as a Nodal Officer for the purpose of reporting of the annual energy audit and periodic energy accounting and communicate the same to the Bureau.
		b	Electricity distribution company ensures that the energy accounting data is generated from a metering system or till such time the metering system is not in place, by an agreed method of assumption as may be prescribed by the State Commission.	yes
		c	Metering of distribution transformers at High Voltage Distribution System up to 25KVA is done on cluster meter installed by the electricity distribution company	N.A.
		d	The energy accounting and audit system and software is developed to create monthly, quarterly and yearly energy accounting reports.	reports are manually prepared. The software for Meter Management Data is in progress & it will implement at the earliest.





Annual Energy Audit of EDA&N FY 2023-24

Clause	Details	Sub-Clause	Criteria	Compliance Status
		c	Electricity distribution company has provided the details of the information technology system in place as specified in clause (f) of regulation 5 that ensures minimal manual intervention in creating the energy accounting reports and any manual intervention of any nature, in respect of the period specified therein, shall be clearly indicated in the periodic energy accounting report	being done





## 6.5. Revised findings based on data validation and field verification

In EDA&N discom, there is No Internal Connection Between any of the Island. Each Island has its own connected network, due to which if there is a fault in one of the circuits, the complete network is interrupted and again 30 min time is required to reenergise the network after clearing the fault. Solar Generation is also a constraint as during the daytime, consumption is restricted. This is observed in the Head Quarter Division.

The number of distribution transformers are increased in the urban areas in order to reduce the voltage drop by extending the 11kV network however, this has resulted in an increase in transformation loss as the DTR of higher capacity are installed which are loaded at 20 to 25 % of peak demand.

The generation capacity is restricted due to which loads are required to be tripped during the Peak Loading Hours.

The rural areas have extended LT Networks, which contributed to LT loss, can be reduced by implementing HVDS systems.

The RMUS needs to be installed with proper study in order to separate the lines due to occurrence of the fault.

The One Nation One Grid, plan shall be implemented in order to cater to the demand of the EDA&N.

## 6.6. Inclusion and Exclusions

No inclusion & Exclusion.





## 7. Conclusion and Action Plan

### 7.1. Summary of Critical Network Analysis by Energy Auditor

#### 7.1.1. Purchased Energy for 2023-2024

The purchased energy for FY 2023-2024 is show below.

Table 26 Purchased Energy FY 2023-2024

DC	Type	Purchased Energy (MU)	Remarks
EDA & N	DISCOM	<b>382.45</b>	Total Energy purchased by EDA & N .

#### 7.1.2. Net Input Energy

The energy recorded at the Interface point of transmission and EDA & N Distribution network is **368.33** MU for FY 2023-2024.

##### 7.1.2.1. Net Input Energy Details FY 2023-2024

EDA &	Type	Net Input Energy (MU)	Remarks
EDA & N	DISCOM	<b>368.33</b>	Net input energy (at DISCOM Periphery after adjusting the transmission losses and energy traded)

#### 7.1.3. Billed energy 2023-2024

Table 27 Billed energy FY 2023-2024

Sr. No	Billed Energy (MU)	Data Source
1	<b>299.18</b>	As per the submitted data by the EDA & N team

#### 7.1.4. Energy Balance -2023-24

Name of circle	Input energy (MU)	Total Billed energy (MU)	T&D loss (MU)	T&D loss (%)	Billed Amount in Rs. Crore	Collected Amount in Rs. Crore	Collection Efficiency	AT & C loss (%)
<b>Total</b>	<b>368.33</b>	<b>299.18</b>	<b>69.15</b>	<b>19%</b>	<b>256.74</b>	<b>246.13</b>	<b>95.87%</b>	<b>22%</b>







Annual Energy Audit of EDA&N FY 2023-24

7.1.5. Energy Distribution Verification

	Parameters	Total
i	Number of circles	1
ii	Number of divisions	7
iii	Number of sub-divisions	33
ix	Total Number of feeders	65
x	Total Number of DTs	8
xi	Total capacity of the DTs in KVA	1082
xii	Number of consumers	154731

	Parameters	66kV and above	33kV	11kV/22kV	LT
a.	Number of conventional metered consumers (Electronic Meters)				
i.	Number of consumers with 'smart' meters		0	0	76000
ii	Number of consumers with 'smart prepaid' meters		0	0	0
iii	Number of consumers with 'AMR' meters				0
iv	Number of consumers with 'non-smart prepaid' meters		0	0	86000
v	Number of unmetered consumers		0	0	0
vi	<b>Number of total consumers</b>				154731
b.i.	Number of conventionally metered Distribution Transformers (Electronic Meters)		0	0	0
ii	Number of DTs with communicable meters		0	0	
iii	Number of unmetered DTs		4	1	0
iv	<b>Number of total Transformers</b>		0	0	1109
c.i.	Number of metered feeders		11	46	4
ii	Number of feeders with communicable meters		0	0	0
iii	Number of unmetered feeders		0	4	0
iv	<b>Number of total feeders</b>		11	50	4
d.	Line length (ct km)		590.16	895.07	3816.79
e.	Length of Aerial Bunched Cables		33.84	175.91	725.76
f.	Length of Underground Cables		79.71	77.91	154.03





Annual Energy Audit of EDA&N FY 2023-24

	Voltage level	Energy Sales Particulars	MU
i	LT Level	DISCOM' consumers	299
		Demand from open access, captive	0
		Embedded generation used at LT level	0
		Sale at LT level	299
		Quantum of LT level losses	69
		Energy Input at LT level	368
ii	11 kV Level	DISCOM' consumers	0
		Demand from open access, captive	0
		Embedded generation at 11 kV level used	
		<b>Sales at 11 kV level</b>	0
		Quantum of Losses at 11 kV	0
		Energy input at 11 kV level	0
iii	33 kV Level	DISCOM' consumers	
		Demand from open access, captive	
		Embedded generation at 33 kV or below level	
		<b>Sales at 33 kV level</b>	0
		Quantum of Losses at 33 kV	0
		Energy input at 33kV Level	
iv	> 33 kV	DISCOM' consumers	
		Demand from open access, captive	
		Cross border sale of energy	
		Sale to other DISCOMs	
		Banking	
		Energy input at > 33kV Level	
		<b>Sales at 66kV and above (EHV)</b>	0
<b>Total Energy Requirement</b>			<b>368</b>
<b>Total Energy Sales</b>			<b>299</b>

7.1.6. Verification of Yearly Reports

7.1.6.1. Yearly energy consumption data of the consumers

Consumer category	Input energy	Total energy	T&D loss	T&D loss (%)	Billed Amount in Rs. Crore	Collected Amount in Rs.crore	Collection Efficiency	AT & C loss AT & C loss (%)
Residential	368.33	168.10	69.149	19%	73.5156	70.518	95.92%	22%
Agricultural		1.696			0.5018	0.317	63.37%	





Annual Energy Audit of EDA&N FY 2023-24

Consumer category	Input energy	Total energy	T&D loss	T&D loss (%)	Billed Amount in Rs. Crore	Collected Amount in Rs.crore	Collection Efficiency	AT & C loss AT & C loss (%)
Commercial/Industrial-LT		68.34			91.870	85.499	93.07% 0.00%	
Commercial/Industrial-HT		0.00			0.00	98.83%		
Others		61.03			89.79	95.92%		
<b>Sub-total</b>		<b>368.33</b>			<b>299.18</b>	<b>69.149</b>	<b>19%</b>	

Review of the current consumption practices in order to identify the energy loss in the system was carried out.

Table 28 : Details of Consumer

S.No	Type of Consumers	Category of Consumers (EHT/HT/LT/Others)	Voltage Level (In Voltage)	No of Consumers	Total Consumption (In MU)	Remarks (Source of data)
1	Domestic	LT	0.415	129580	168.12	
2	Commercial	LT	0.415	21102	60.32	
3	IP Sets					
4	Hor. & Nur. & Coffee/Tea & Rubber (Metered)					
5	Hor. & Nur. & Coffee/Tea & Rubber (Flat)					
6	Heating and Motive Power					
7	Water Supply					
8	Public Lighting	LT	0.415	764	4.84	
9	HT Water Supply					
10	HT Industrial					
11	Industrial (Small)					
12	Industrial (Medium)	LT	0.415	423	11.02	
13	HT Commercial					
14	Applicable to Government Hospitals & Hospitals					
15	Lift Irrigation Schemes/Lift Irrigation Societies					
16	HT Res. Apartments Applicable to all areas					





S.No	Type of Consumers	Category of Consumers (EHT/HT/LT/Others)	Voltage Level (In Voltage)	No of Consumers	Total Consumption (In MU)	Remarks (Source of data)
17	Mixed Load					
18	Government offices and department					
19	Others-1 (if any , specify in remarks)	HT/LT	11/.415	2862	55.12	
20	Others-2 (if any , specify in remarks)					
21	Others-3 (if any , specify in remarks)					
22	Others-4 (if any , specify in remarks)					
23	Others-5 (if any , specify in remarks)					
<b>Total</b>				<b>154731</b>	<b>299.42</b>	

## 7.2. Summary of Key Findings-Energy balance and losses

The Energy balance and losses of EDA & N for FY 2023-24 are as shown in the table below:

Table 29: Energy balance and losses

(i)	Input Energy Purchase (From Generation Source)	Million kwh	382.45
(ii)	Net input energy (at DISCOM Periphery after adjusting the transmission losses and energy traded)	Million kwh	368.33
(iii)	Total Energy billed (is the Net energy billed, adjusted for energy traded))	Million kwh	299.18
(b)	Transmission and Distribution (T&D) loss Details	Million kwh	69.15
		%	18.77%
	Collection Efficiency	%	96%
(c)	Aggregate Technical & Commercial Loss	%	22%

## 7.3. Recommendation– Energy Accounting, Loss reduction and energy conservation

The implementation of a High Voltage Distribution System (HVDS) in the Andaman and Nicobar Islands can significantly reduce energy losses, particularly given the current scenario where transformers are operating at only 40% to 60% capacity and experiencing unbalanced loads.

Reduction in Losses: HVDS operates at higher voltages, which results in lower currents for the same power transfer. This reduction in current leads to decreased resistive losses, which are a major component of energy loss in electrical systems. In contrast, traditional low-voltage





distribution systems suffer from higher currents, resulting in increased losses due to heat generation in the lines.

- Improved Transformer Efficiency: With transformers often underloaded, HVDS can optimize their operation by ensuring they operate closer to their rated capacity. This not only enhances efficiency but also reduces the likelihood of transformer overheating and failure.
- Balanced Load Distribution: HVDS can help in achieving a more balanced load across the network. By placing distribution transformers closer to consumers and reducing the length of low-voltage lines, it minimizes the risk of unbalanced loading, which can lead to further losses and equipment stress.
- Minimized Technical Losses: The transition from low-voltage distribution to HVDS reduces technical losses associated with long low-voltage lines. By converting these lines to higher voltage (e.g., 11 kV), energy can be transmitted more efficiently, maintaining better voltage profiles throughout the distribution network.
- Enhanced Reliability and Quality of Supply: HVDS not only reduces losses but also improves the overall reliability of power supply. It mitigates issues such as voltage drops and outages caused by overloads and unauthorized connections, which are prevalent in existing low-voltage systems.

The adoption of a High Voltage Distribution System in the Andaman and Nicobar Islands presents an effective solution to reduce energy losses, enhance transformer performance, and improve overall power quality. This transition is essential for creating a more sustainable and reliable electricity supply for the region, addressing both current inefficiencies and future energy demands.

Considering an annual energy consumption of **334 MU** (Million Units), the impact of implementing a High Voltage Distribution System (HVDS) can be analyzed in terms of cost savings and reduction in transformation losses.

This reduction in losses not only leads to significant cost savings but also enhances the overall efficiency of the power distribution system in the Andaman and Nicobar Islands.

Implementing HVDS not only provides substantial cost savings but also significantly enhances energy efficiency by reducing transformation losses in the Andaman and Nicobar Islands' power distribution network.

It is recommended that, detailed load flow study to be carried out by the Discom in order to understand the pockets of energy loss and the metering to be implemented as per the regulations.

This will enable discom network to meet the future load demand with minimum down time.





## 7.4. Action Plan for monitoring and reporting

Energy monitoring shall be carried out remotely in compliance to the regulation and the monitoring of the transformer load, consumer consumption as per the compliance.

IT network shall be in place in order to monitor the Distribution Transformer loading. Smart meters shall be integrated with MDM and monitoring

## 7.5. Action plan for automated energy accounting

Automated energy accounting systems shall be implemented for consumers, with AMR meters to be installed at the 33 kV, and 11 kV feeder levels, as well as at distribution transformer (DTR) locations from subsequent substations. This setup will enable the monitoring and accounting of various voltage levels through a unified software platform.





## 8. ANNEXURES

### Annexure I- Introduction of Verification Firm

General Information				
1	Name of the DISCOM	Electricity Department, A&N Administration		
2	i) Year of Establishment	1926		
	ii) Government/Public/Private	Government		
3	DISCOM's Contact details & Address			
i	City/Town/Village	Aberdeen Bazar		
ii	District	South Andaman		
iii	State	A&N Islands	Pin	744101
iv	Telephone	03192-232404	Fax	03192-233365
4	Registered Office			
i	Company's Chief Executive Name	Madhuri Shukla		
ii	Designation	Superintending Engineer (Tech.)		
iii	Address	Vidyut Bhavan		
iv	City/Town/Village	Sri Vijaya Puram, South Andaman	P.O.	Sri Vijaya Puram
v	District	South Andaman		
vi	State	A&N Islands	Pin	744101
vii	Telephone	03192-232404	Fax	03192-233365
5	Nodal Officer Details*			
i	Nodal Officer Name (Designated at DISCOM's)	Hema Devi		
ii	Designation	Assistant Engineer		
iii	Address	Vidyut Bhavan		
iv	City/Town/Village	Sri Vijaya Puram, South Andaman	P.O.	
v	District	South Andaman		
vi	State	A&N Islands	Pin	744101
vii	Telephone	8900921626	Fax	
6	Energy Manager Details*			
i	Name	Yet to be appointed		
ii	Designation	NA	Whether EA or EM	NA
iii	EA/EM Registration No.	NA		
iv	Telephone	Na	Fax	Na
v	Mobile	Na	E-mail ID	-
7	Period of Information			
	Year of (FY) information including Date and Month (Start & End)	1st APRIL, 2023 - 31th MARCH, 2024		





## Annexure II - Minutes of Meeting with the DISCOM team

### Minutes of Meeting (MoM)

**Purpose:** Data Requirements for Annual Energy Audit as per BEE Regulation

**Attendees:**

- Head of the Cell: Assistant Engineer (PL-II)
- Finance Manager: Asst. Accounts Officer
- Energy Manager: In Process
- IT Manager: Assistant Engineer (IT)

### Agenda: Collection of Data for Annual Energy Audit

- 1. Identification and Mapping of Electrical Network Assets**
  - **Requirement:** Identification and mapping of electrical network assets; SLD of islands
  - **Action:** Will be provided upon site visit.
- 2. Energy Accounting and Audit System Details**
  - **Requirement:** Details of energy accounting and audit system and software used for monthly, quarterly, and yearly energy reports
  - **Response:** As per BEE-prescribed formats.
- 3. Energy Purchase Reports for FY 2022-23 and FY 2023-24**
  - **2022-23:** 382.48 MU
  - **2023-24:** 281.39 MU
- 4. Power Generation Capacity – Up Time and Down Time**
  - **2022-23:** 127 MW
  - **2023-24:** 139 MW
- 5. Peak Demand of Network Systems for Various Islands**
  - **2022-23:** 63 MW
  - **2023-24:** 65 MW
- 6. Feeder/Division-wise Peak Demand (Different Islands)**
  - **2022-23:**
    - South Andaman: 48.44 MW
    - N&M Andaman: 10.37 MW
    - Nicobar: 4.19 MW
  - **2023-24:**
    - South Andaman: 51.45 MW
    - N&M Andaman: 10.81 MW
    - Nicobar: 2.98 MW
- 7. Power Distribution Transformer Load and Peak Demand**
  - **2022-23:**
    - Power Transformers: 25 Nos.
    - Distribution Transformers: 1041
  - **2023-24:**
    - Power Transformers: 27 Nos., Connected Load: 23.525 MVA
    - Distribution Transformers: 1082 Nos., Connected Load: 203.148 MVA
- 8. Average Billing Rate**
  - **2022-23:** Rs. 7.80







- o 2023-24: Rs. 10.23

**9. SAIDI and SAIFI Data**

- o 2022-23:

- SAIFI (Average): Urban: 2705, Rural: 1163
- SAIDI: Not available

- o 2023-24:

- SAIFI (Average): Urban: 1694, Rural: 1207
- SAIDI: Not available

**10. Generation Meters and Feeder Meters.**

- o Generation meters available presently are of panel meters with the accuracy class 0.5.
- o It is suggested to install the 0.2s class meters at every generation units.
- o 0.2s meter are observed in hiring power plant at LT side.
- o The meters installed at HT side will reduce the transformer losses in both hiring power plants and in case of dedicated transformers of the consumers.

**11. Maintenance Practices for Power Substation, HT and LT Lines, DTR**

**Action:**

- Maintenance of distribution transformers are carried out on failure of the transformers and not on periodic basis, similarly the transformers are aged and needs periodic maintenance to reduce the losses.
- To reduce the line losses, HVDS with single phase distribution transformers upto 10 kVA, 16 kVA, etc shall be proposed in Diglipur, Rangat, Rural areas of south Andaman, etc.
- Low voltages observed in urban area of Shri Vijayapuram (South Andaman) Hence Technical study of distribution Network for low voltage shall be carried out.

**11. True-up Data for FY 2023-24 and FY 2024-25**

- **Action:** true-up data will be provided on finalization.

**12. Percentage of Renewable Energy Purchased**

- 2023-24: 9.77% of total purchased energy

**13. Grid Modification Projects**

- **Action:** No detailed response; to be updated during a future visits.

**14. Team Member Details (As per Regulation)**

- Head of the Cell: Assistant Engineer (PL-II), Mob. No.: 8900921626, Email: energyaudit.ele@gmail.com
- Finance Manager: Asst. Accounts Officer, Mob. No.: 9434272270, Email: munmun.baral@and.nic.in
- Energy Manager: In process





- IT Manager: Assistant Engineer (IT), Mob. No.: 9434281023, Email: itcellepb@gmail.com

#### Energy Audit Reports Submitted

- Quarterly and annual energy audit reports for FY 2022-23 and FY 2023-24 have been submitted to BEE.

#### 16. RDSS Scheme Status

- **Action:** Updates will be provided on actual implementation.

#### Conclusion:

- Generation Metes installations is suggested for accurate power intake.
- HVDS Line for line loss reduction and voltage improvement is suggested.
- Some data points will be provided during site visits, including SLD of islands, maintenance practices, and true-up data.
- The majority of the required data, such as energy purchase reports, peak demands, SAIDI/SAIFI, and renewable energy percentage, has been provided for the annual audit.

#### Next Steps:

- Schedule a site visit to gather remaining information.

#### Discussion Points:

##### 1. Clarification of Pending Data:

- **Identification and Mapping of Electrical Network Assets (SLD of islands):** Confirm the timeline for providing this information during the site visit. Ensure the client understands the criticality of this data for compliance with BEE regulations.
- **Maintenance Practices (Power Substations, HT & LT lines, DTR):** Discuss the best time to inspect these during the visit and emphasize their importance in meeting audit requirements.
- **True-up Data for FY 2023-24 and FY 2024-25:** Clarify how and when this data will be made available during the visit, ensuring it aligns with the audit submission deadlines.

##### 2. Energy Purchase Reports & Peak Demand:

- Discuss the energy purchase trends for FY 2022-23 and FY 2023-24 (382.48 MU vs. 281.39 MU) and understand any deviations or significant changes.



- Review the peak demand data across different islands (especially the slight increase in South Andaman) and ask if any significant events or projects influenced these numbers.
- 3. **Renewable Energy:**
  - The percentage of renewable energy purchased for FY 2023-24 (9.77%) is a key metric. Ask about the client's plans to increase this percentage and any challenges they are facing with renewable energy procurement or integration into the grid.
- 4. **Grid Modification Projects:**
  - Since this data wasn't provided yet, it's essential to understand what grid modification projects are planned or in progress. Ensure this information is detailed and discuss potential impacts on the energy audit process.
- 5. **SAIDI/SAIFI Data:**
  - The SAIFI data for urban and rural areas has shown improvement between FY 2022-23 and FY 2023-24. Confirm with the client what steps or initiatives led to this improvement, and ask if they have a plan to address the missing SAIDI data.
- 6. **Team Member Details:**
  - Discuss the team structure, including the new Energy Manager role that remains unfilled. Highlight the importance of this position in managing audit software and energy management systems.
- 7. **RDSS Schemes:**
  - Address the current status of the RDSS schemes and the work planned. Since this will be updated later, agree on a clear timeline for providing this information and discuss any ongoing challenges with these schemes.
- 8. **Quarterly and Annual Audit Reports:**
  - Confirm the submission timeline for future reports and ensure there are no issues with meeting BEE deadlines.

#### Action Items:

- Finalize the schedule for the **site visit** to gather pending data (SLD, maintenance practices, true-up data).
- Review the renewable energy strategy and discuss potential areas for increasing its share in the energy mix.
- Set a timeline for receiving updates on **grid modification projects** and **RDSS schemes**.

#### Next Steps:

- Coordinate with the client on the site visit timeline.
- Follow up on any **unresolved data requirements** and ensure a clear path toward completing the audit process.

  
Ravi Deshmukh (AEA)



  
Hema Devi (AE, PL-II)

सहायक अभियंता (योजना-II)  
Assistant Engineer (PL-II)  
विद्युत विभाग / Electricity Department  
विद्युत भवन / Vidyut Bhavan  
पोर्ट ब्लेयर / Port Blair



## Annexure III - Check List prepared by auditing Firm

The check list prepared for Annual Energy Audit is presented in the following table:

Sr.No	Description
1	Energy Purchase Documents- Power Purchase report from all sources
2	Consumers Category wise details
3	Billed energy for different category of the consumer
4	Annual Calculation of transmission Loss
5	Annual EHT Sales Report-
6	Sample 33kV input and billed energy
7	DTR and consumer mapping for the LT loss calculation
8	Average Billing Rate for consumer category
9	Feeder wise injected energy into the network
10	Open access consumers and their consumption details
11	Infrastructure details





## Annexure IV - Brief Approach, Scope & Methodology for audit

1. Kick off meeting with EDA&N Team to finalize the sample size
2. Survey of the Distribution network
3. Collection of the Primary Data and finalization of the sample size check
4. Site visit and Energy Meter data collection
5. Collection of the Metered Energy Data for the respective voltage level as per the sample size
6. Scrutiny of collected data and Data gaps of the submitted data
7. Loss calculation for the network segment then if required normalization
8. Compilation of the Draft report
9. Presentation on Draft report
10. Final report with incorporation of comments

As per the methodology, after collection of the data, site visit carried out at EDA&N in month of September 2024, along with EDA&N Team and consultant team.

## Annexure V - Infrastructure Details

EDA&N has a vast infrastructure facility in its operating area with the following infrastructure details:

Sr.No	Particulars	As on 22 September 2024
1	Number of circles	1
2	Number of divisions	7
3	Number of sub-divisions	33
4	Number of feeders	65
5	No of 33/11 KV Substations	NA
6	Length of 33 KV line (KM)	590.165
7	Length of 11 KV line (KM)	895.072
8	Length of Low-tension line (KM)	3816.796
9	Length of Aerial Bunched Cables	935.525
10	Length of Underground Cables	311.655
11	Number of Distribution Transformers	1082
12	Connected load (kW)	154731





## Annexure VI - Electrical Distribution System

Andaman & Nicobar Islands (hereinafter referred to as “A&N”) is a cluster of islands scattered in the Bay of Bengal and a designated Union Territory of India. These islands are separated from the rest of India by more than 1000 kms. The total area of the territory is 8,249 sq.km out of which the forest cover is about 7,589 sq. km. (92%). A&N is having population of 379,944 as per census provisional records and average growth rate of population is 6.68%. These islands are divided in three districts, viz., Andaman, Nicobar and North & Middle Andaman. The seat of the Administration is at Sri Vijaya Puram (South Andaman) in which 14.14 sq. km. area is under the jurisdiction of Sri Vijaya Puram Municipal Council.

The tempo of economic development has tremendously accelerated along with all-round expansion in the areas/ sectors, viz., (i) Shipping Services, (ii) Civil Supplies, (iii) Education, (iv) Fisheries, (v) Tourism & Information Technology, (vi) Health, (vii) Industries, (viii) Rural Development, (ix) Social Welfare, (x) Transport, (xi) Increase in District Headquarters, (xii) Central Government Department, (xiii) Public Undertaking & other offices, (xiv) Services & Utilities, (xv) Defence Establishment, (xvi) Commercial Organizations/Business Centers, etc. Thus, these islands have reached the take off stage for total economic transformation. All these economic and infrastructure developments require power as a vital input and to play a key role for achieving overall transformation.



### Andaman Group of Islands

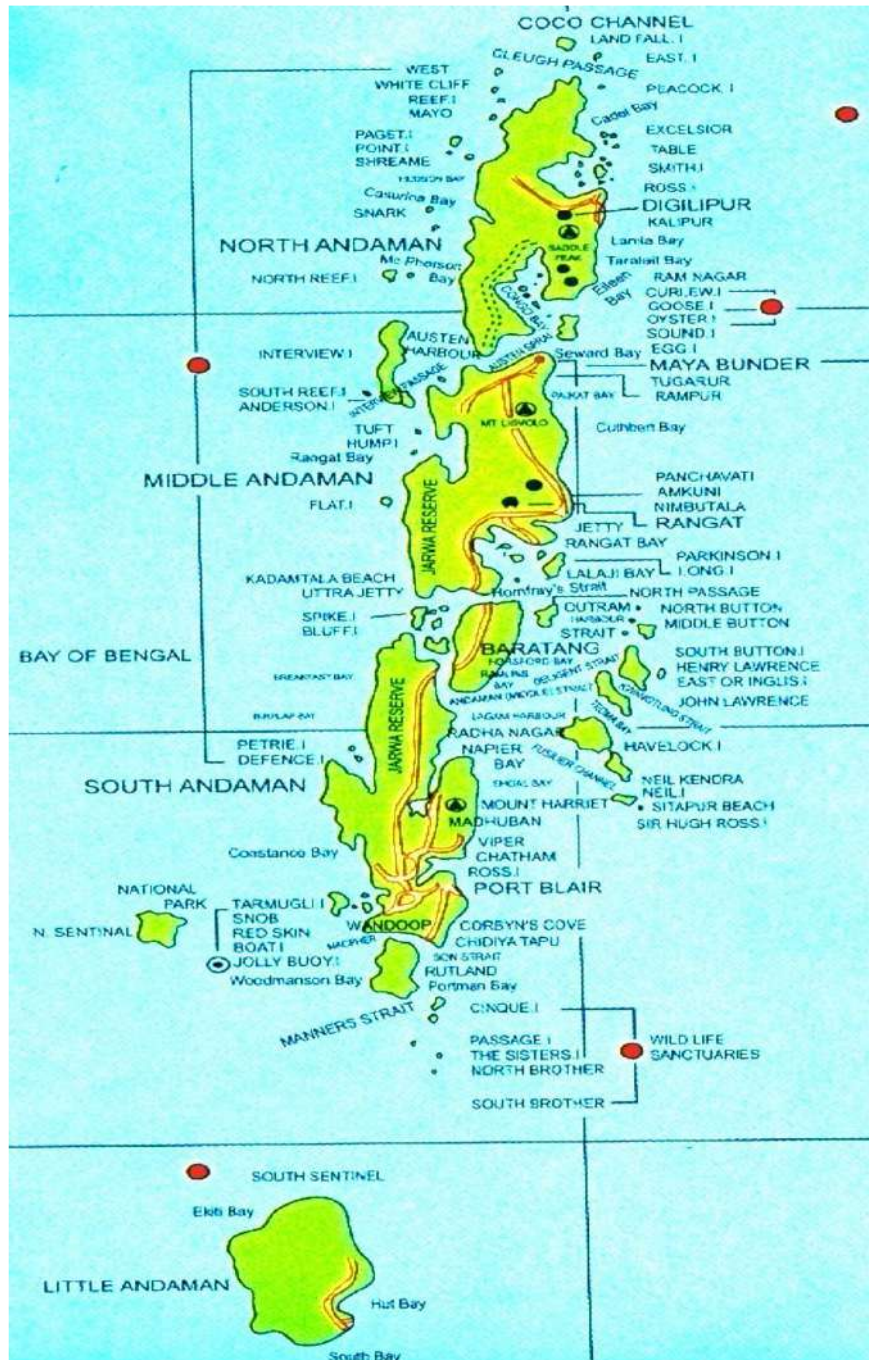



### Nicobar Group of Islands

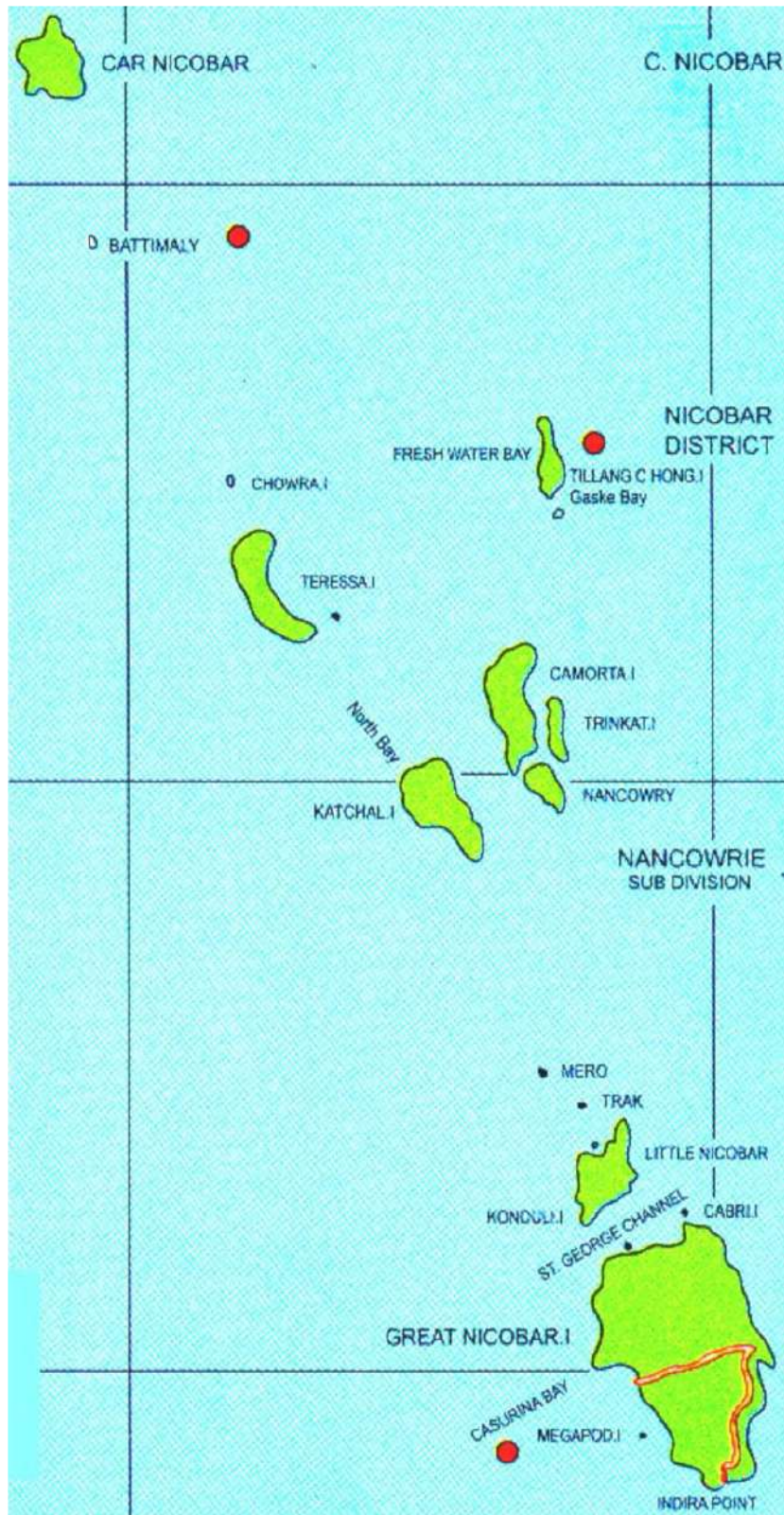





## Annexure VII – Power Purchase Details

Purchased Power is derived from the Generated energy and from Private agencies.

Sr.No	Power Plant	Units Generated (MUs)
1	Private Power Plants	281.39
2	Government Power Plants	101.06
<b>Total Units Generated</b>		<b>382.45</b>





Annual Energy Audit of EDA&N FY 2023-24

### Annexure VIII Line Diagram (SLD)

#### Single Line Diagram Showing Outer Feeder-

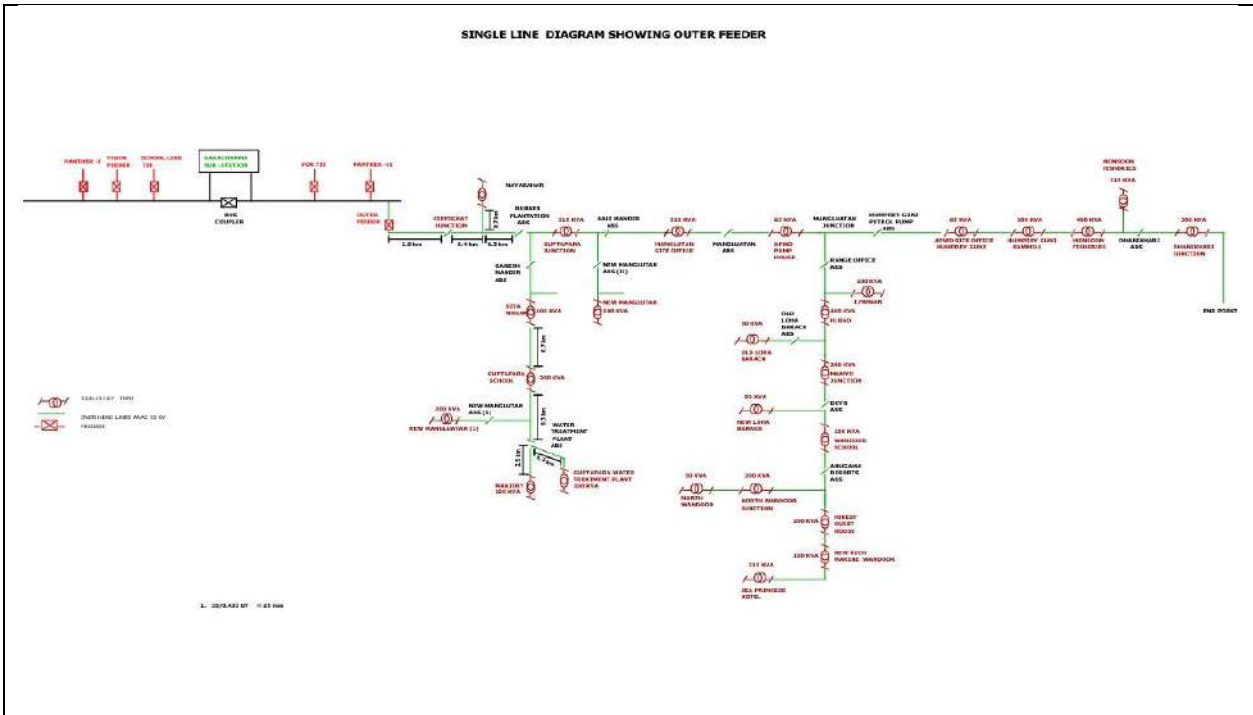

#### Single Line Diagram Showing Tiger Feeder-

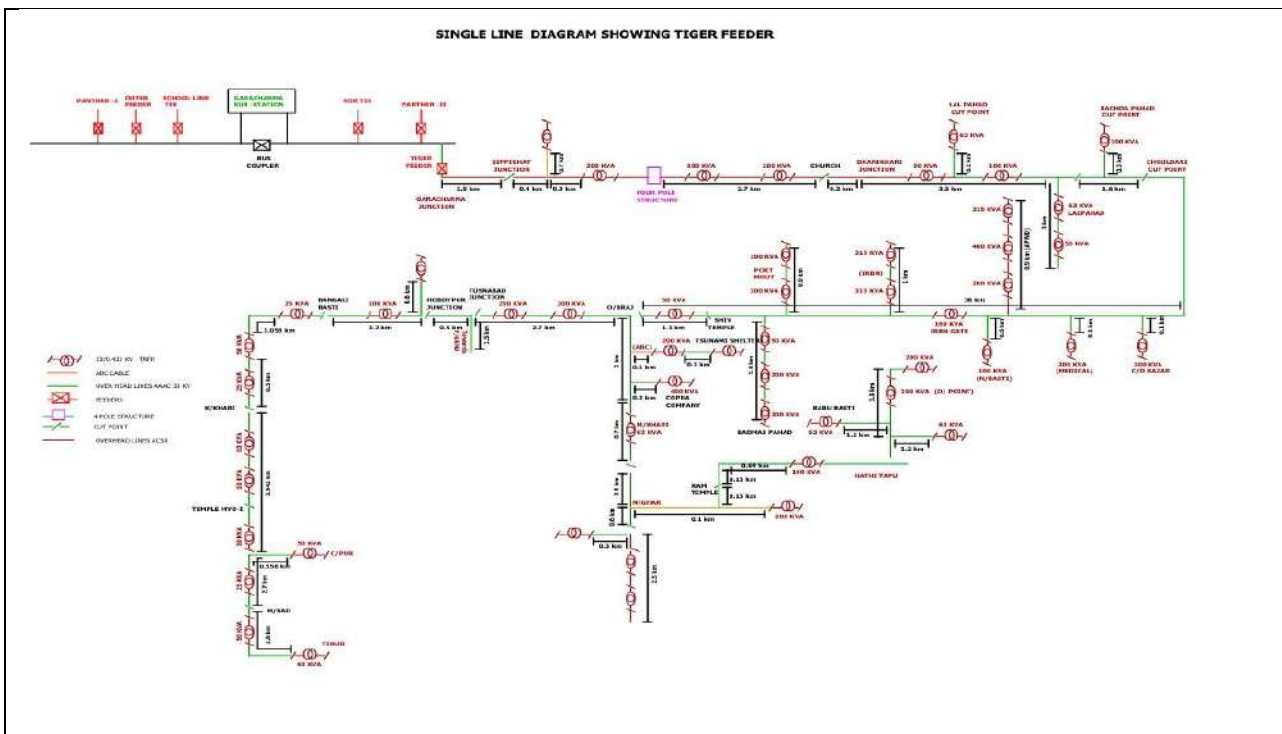



### Single Line Diagram Showing Shoal Bay Ferrargunj Feeder-

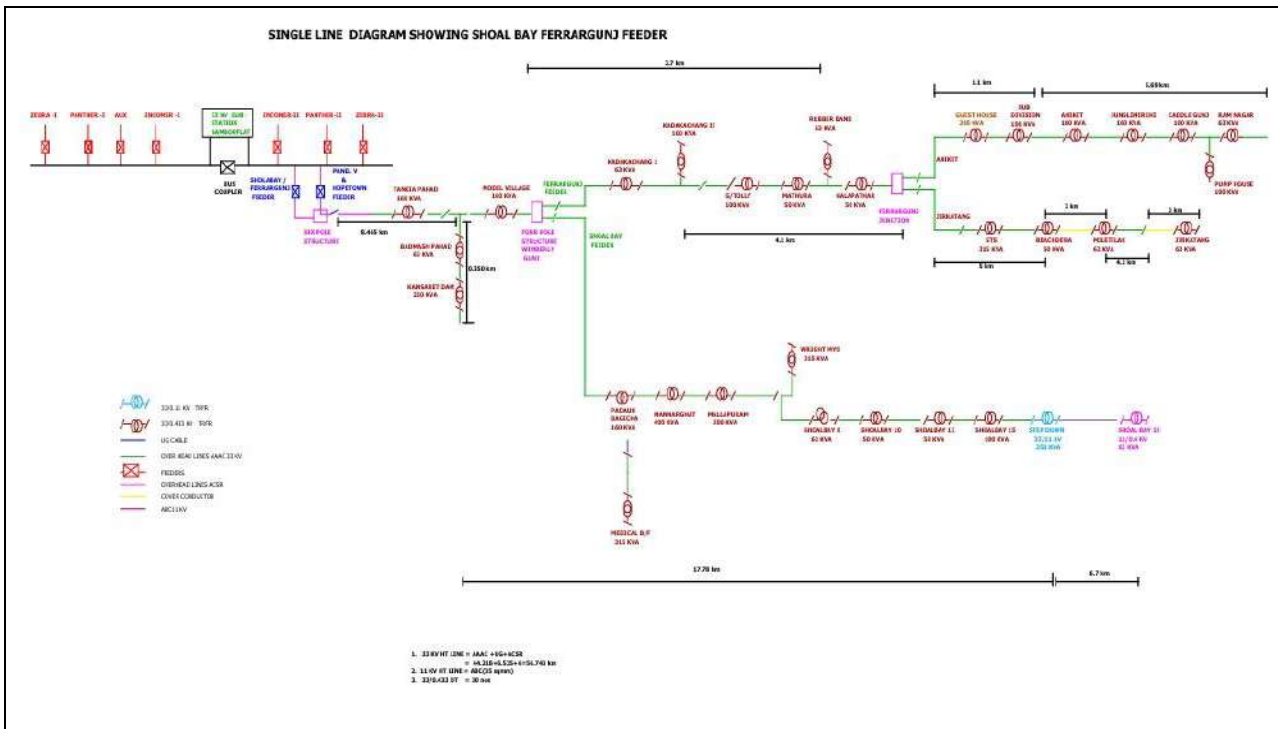

### Single Line Diagram Showing Panel –V and Hope Town Feeder-

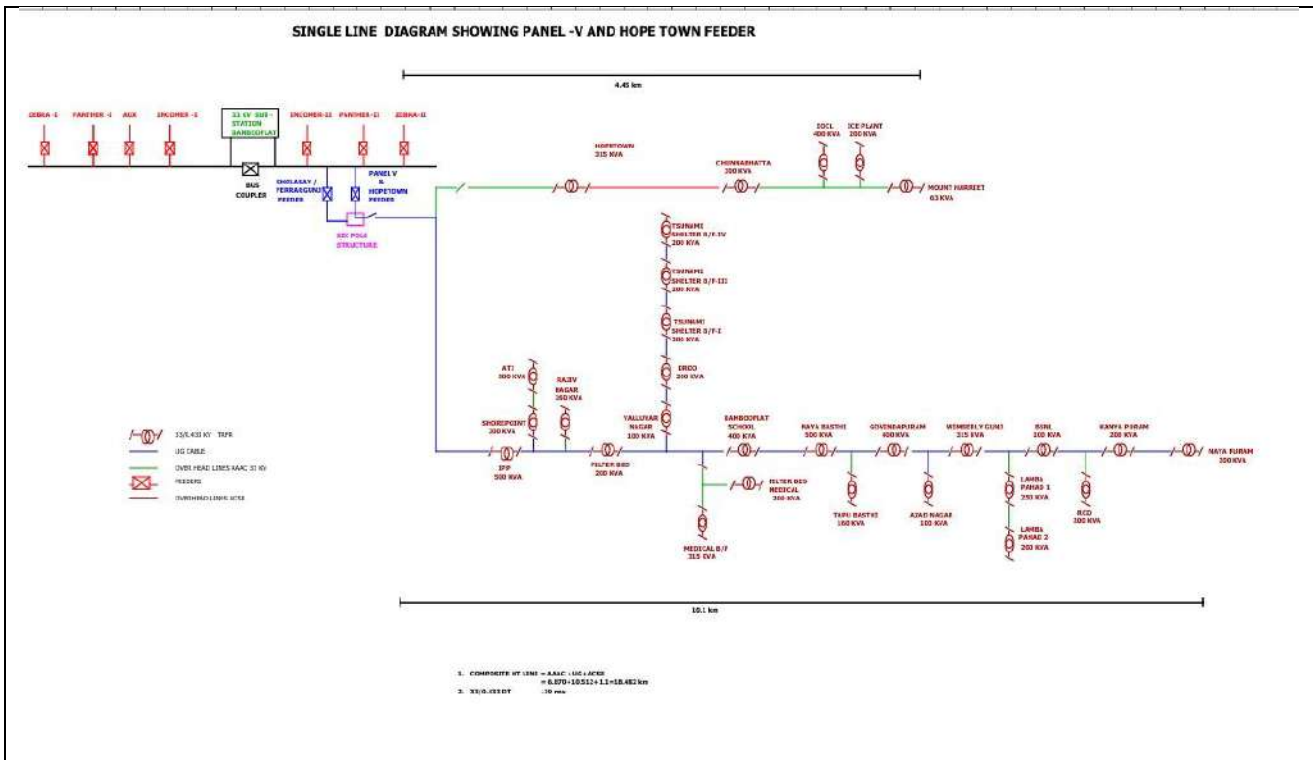

**SINGLE LINE DIAGRAM OF SOUTH ANDAMAN GRID**

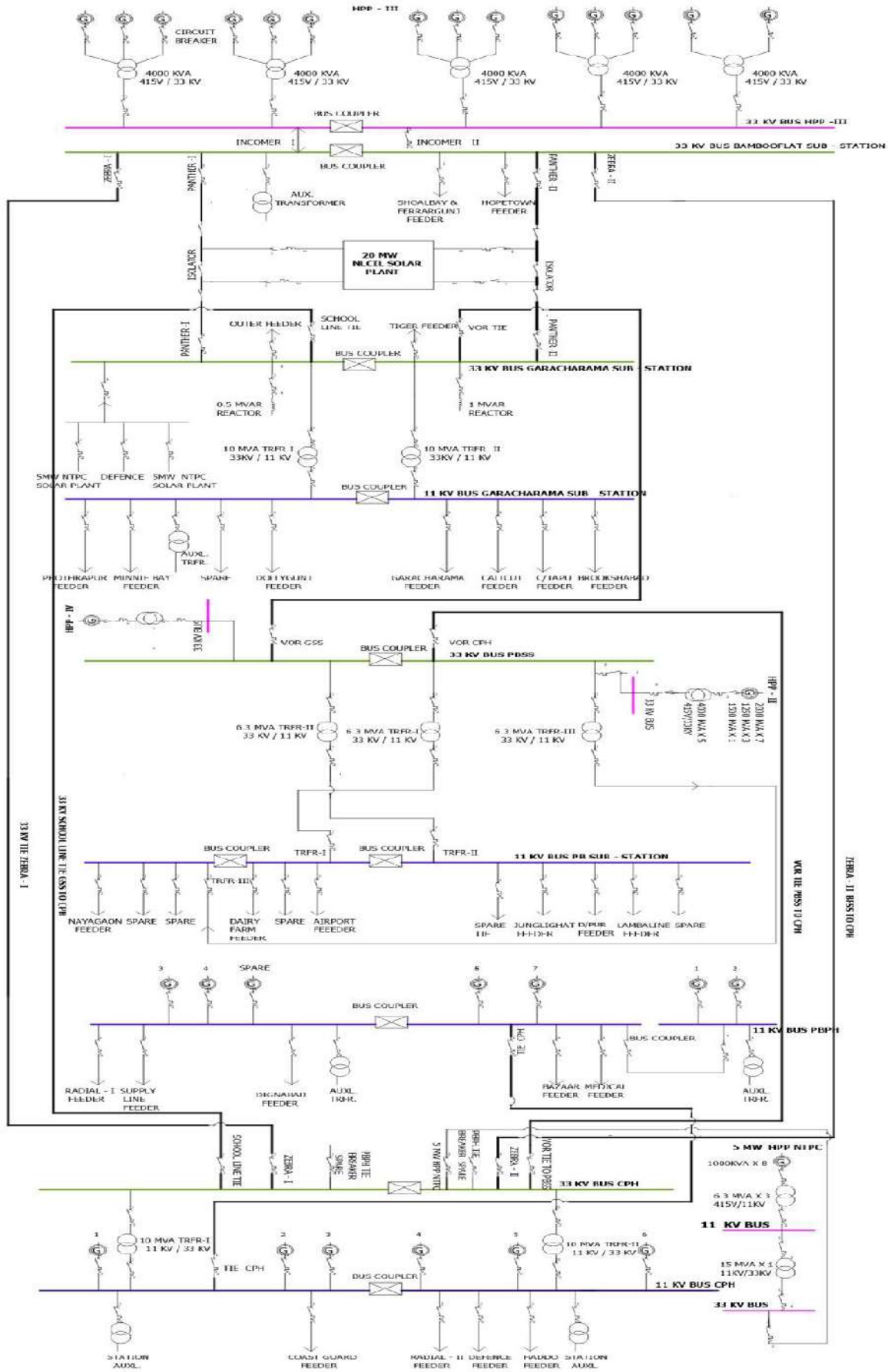



## Annexure IX - Category of service details (With Consumer and voltage-wise)

<b>(Details of Consumers)</b>						
<b>Summary of Energy</b>						
<b>Period From APRIL 2023 To MARCH 2024</b>						
<b>S.No</b>	<b>Type of Consumers</b>	<b>Category of Consumers (EHT/HT/LT/Others)</b>	<b>Voltage Level (In Voltage)</b>	<b>No of Consumers</b>	<b>Total Consumption (In MU)</b>	<b>Remarks (Source of data)</b>
1	Domestic	LT	0.415	129580	168.12	
2	Commercial	LT	0.415	21102	60.32	
3	IP Sets					
4	Hor. & Nur. & Coffee/Tea & Rubber (Metered)					
5	Hor. & Nur. & Coffee/Tea & Rubber (Flat)					
6	Heating and Motive Power					
7	Water Supply					
8	Public Lighting	LT	0.415	764	4.84	
9	HT Water Supply					
10	HT Industrial					
11	Industrial (Small)					
12	Industrial (Medium)	LT	0.415	423	11.02	
13	HT Commercial					
14	Applicable to Government Hospitals & Hospitals					
15	Lift Irrigation Schemes/Lift Irrigation Societies					
16	HT Res. Apartments Applicable to all areas					
17	Mixed Load					
18	Government offices and department					
19	Others-1 (if any , specify in remarks)	HT/LT	11/.415	2862	55.12	
20	Others-2 (if any , specify in remarks)					
21	Others-3 (if any , specify in remarks)					
22	Others-4 (if any , specify in remarks)					
23	Others-5 (if any , specify in remarks)					
			<b>Total</b>	<b>154731</b>	<b>299.42</b>	



## Annexure X Field Verification Data and Reports (Photographs)

### The field verification of the Panels and Distribution network of EDA & N



Office of the Executive Engineer



Phoenix Bay and Chatham and data monitoring Centre



Electrical Control Panel



Annual Energy Audit of EDA&N FY 2023-24



Feeder



DG Unit

Field verification of Meter Reading-



Maya Bunder







Annual Energy Audit of EDA&N FY 2023-24



Old Analog Meter



Government Consumer Meter's

**Field verification of Motor-**



**Water depth around 100 to 150 ft.**



**Transformer**

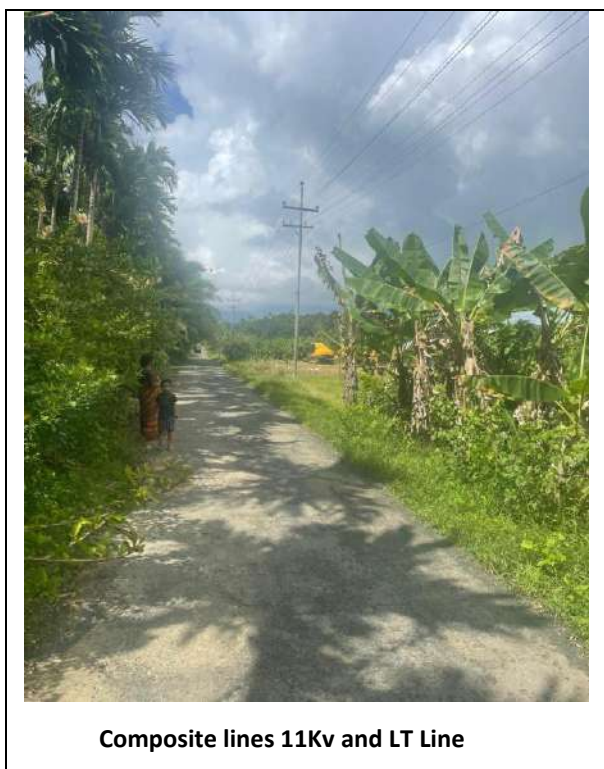

**Single Line Diagram of 11Kv HT Line 1:**

Jurisdiction under Aerial Bay Section, NAD:

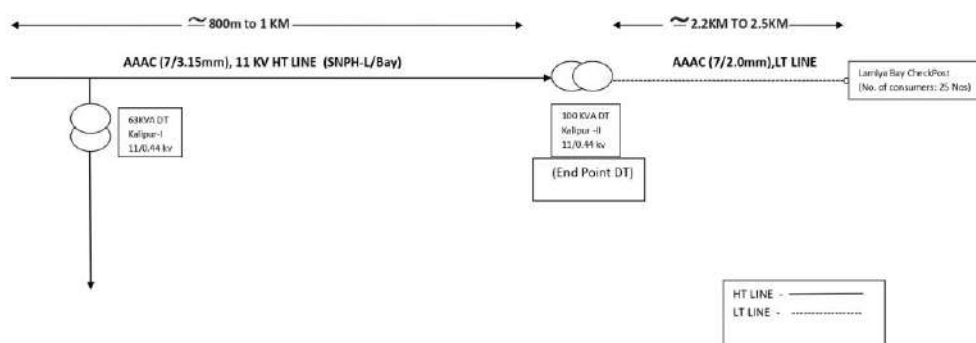



## Annexure XI-List of documents verified with each parameter

The following are the documents verified during Annual Energy Audit:

Parameters	Documents verified
Energy Purchased	Annual Proforma
State Generation	NA
Energy exported/sale	NA
Infrastructure details	NA
Consumer details	Annual Proforma
Energy Billed	Annual Proforma
Collection	Annual Proforma
Energy accounting	NA
Energy injection in different voltage level	NA

## Annexure XII -Brief Description of Unit

The Electricity Department of Andaman & Nicobar Administration (hereinafter referred to as “EDA&N” or “Utility” or “Petitioner”) is solely responsible for power supply in the Union Territory (UT). Power requirements of EDA&N are met by own generating stations as well as power purchase.

Due to the geographical and topographical peculiarities of these islands including separation by sea over great distances, there is no single power grid for the entire electrified islands, instead, powerhouse at various islands caters independently to the power requirements of area/islands.

EDA&N is operating and maintaining power generation, transmission and distribution system network in these islands for providing electric power supply to general public. It implements various Planned and Non-Planned schemes for augmentation of Diesel Generating Capacity, establishment of new power plants and T&D Systems. EDA&N is also functioning as a Nodal Agency for implementing renewable energy programme of the Ministry of New & Renewable Energy (MNRE) on these islands. ‘Presently, ED A&N is headed by a Superintending Engineer, along with seven Executive Engineers and around thirty-eight Assistant Engineers for carrying out the task of power generation, transmission and distribution to the general public including schemes under renewable energy sources’ under Annexure XII – Brief Description of Unit.

The key duties being discharged by EDA&N are:





## Annual Energy Audit of EDA&N FY 2023-24

- Laying and operating of electric lines, sub-stations and electrical plants that are primarily maintained for the purpose of distributing electricity in the area of Andaman & Nicobar Islands.
- Operating and maintaining sub-stations and dedicated transmission lines connected therewith as per the provisions of the Act and the rules framed there under.
- Generation of electricity for the supply of electricity required within the boundary of the UT and for the distribution of the same in the most economical and efficient manner.
- Supplying electricity, as soon as practicable to any person requiring such supply, within its competency to do so under the said Act.
- Implementation of schemes for distribution and generally for promoting the use of electricity within the UT.

The present Installed Capacity of EDA&N is approximately 139 MW from various generating stations. The current demand mainly comprises of the domestic and commercial category, which contributed approximately 80% to the total sales of the EDA&N.



## General Information

<b>1</b>	<b>Name of the DISCOM</b>	Electricity Department, A&N Administration		
<b>2</b>	<b>i) Year of Establishment</b>	1926		
	<b>ii) Government/Public/Private</b>	Government		
<b>3</b>	<b>DISCOM's Contact details &amp; Address</b>			
<b>i</b>	City/Town/Village	Aberdeen Bazar		
<b>ii</b>	District	South Andaman		
<b>iii</b>	State	A&N Islands	Pin	744101
<b>iv</b>	Telephone	03192-232404	Fax	03192-233365
<b>4</b>	<b>Registered Office</b>			
<b>i</b>	Company's Chief Executive Name	Madhuri Shukla		
<b>ii</b>	Designation	Superintending Engineer (Tech.)		
<b>iii</b>	Address	Aberdeen Bazar		
<b>iv</b>	City/Town/Village	Sri Vijaya Puram,Soth	P.O.	Port Blair
<b>v</b>	District	South Andaman		
<b>vi</b>	State	A&N Islands	Pin	744101
<b>vii</b>	Telephone	03192-232404	Fax	03192-233365
<b>5</b>	<b>Nodal Officer Details*</b>			
<b>i</b>	Nodal Officer Name (Designated at DISCOM's)	Hema Devi		
<b>ii</b>	Designation	Assistant Engineer		
<b>iii</b>	Address	Vidyut Bhavan		
<b>iv</b>	City/Town/Village	Sri Vijaya Puram,Soth	P.O.	
<b>v</b>	District	South Andaman		
<b>vi</b>	State	A&N Islands	Pin	744101
<b>vii</b>	Telephone	8900921626	Fax	
<b>6</b>	<b>Energy Manager Details*</b>			
<b>i</b>	Name			
<b>ii</b>	Designation		Whether EA or EM	
<b>iii</b>	EA/EM Registration No.			
<b>iv</b>	Telephone		Fax	
<b>v</b>	Mobile		E-mail ID	
<b>7</b>	<b>Period of Information</b>			
	Year of (FY) information including Date and Month (Start & End)	1st APRIL, 2023 - 31th MARCH, 2024		

<b>Performance Summary of Electricity Distribution Companies</b>			
<b>1</b>	Period of Information Year of (FY) information including Date and Month (Start & End)	1st APRIL, 2023 - 31th MARCH, 2024	
<b>2</b>	<b>Technical Details</b>		
<b>(a)</b>	<b>Energy Input Details</b>		
(i)	Input Energy Purchase (From Generation Source)	Million kwh	382.45
(ii)	Net input energy (at DISCOM Periphery after adjusting the transmission losses and energy traded)	Million kwh	368.33
(iii)	Total Energy billed (is the Net energy billed, adjusted for energy traded))	Million kwh	299.18
<b>(b)</b>	Transmission and Distribution (T&D) loss Details	Million kwh	69.15
		%	18.77 %
	Collection Efficiency	%	96%
<b>(c)</b>	Aggregate Technical & Commercial Loss	%	22%

**I/We undertake that the information supplied in this Document and Pro-forma is accurate to the best of my knowledge and if any of the information supplied is found to be incorrect and such information result into loss to the Central Government or State Government or any of the authority under them or any other person affected, I/we undertake to indemnify such loss.**

**Authorised Signatory and Seal**

Signature:-  

**Name of Energy Manager\*: Dr.Ravi Deshmukh**

**Registration Number:AEA-0243**

**Name of  
Authorised  
Signatory  
Name of the  
DISCOM:  
Full Address:-**



**Partic Deficits of Input Infrastructure**

4	Partic Deficit	Item	Actual Input	Requirement to Service Output	Partic Deficit
1	1.1	1.1.1	1		
1		1.1.2	1		
1		1.1.3	1		
1		1.1.4	1		
1		1.1.5	1		
1		1.1.6	1		
1		1.1.7	1		
1		1.1.8	1		
1		1.1.9	1		
1		1.1.10	1		
2	2.1	2.1.1	2		
2		2.1.2	2		
2		2.1.3	2		
2		2.1.4	2		
2		2.1.5	2		
2		2.1.6	2		
2		2.1.7	2		
2		2.1.8	2		
2		2.1.9	2		
2		2.1.10	2		
3	3.1	3.1.1	3		
3		3.1.2	3		
3		3.1.3	3		
3		3.1.4	3		
3		3.1.5	3		
3		3.1.6	3		
3		3.1.7	3		
3		3.1.8	3		
3		3.1.9	3		
3		3.1.10	3		
4	4.1	4.1.1	4		
4		4.1.2	4		
4		4.1.3	4		
4		4.1.4	4		
4		4.1.5	4		
4		4.1.6	4		
4		4.1.7	4		
4		4.1.8	4		
4		4.1.9	4		
4		4.1.10	4		
5	5.1	5.1.1	5		
5		5.1.2	5		
5		5.1.3	5		
5		5.1.4	5		
5		5.1.5	5		
5		5.1.6	5		
5		5.1.7	5		
5		5.1.8	5		
5		5.1.9	5		
5		5.1.10	5		

1	1.1	1
2	2.1	2
3	3.1	3
4	4.1	4
5	5.1	5





















**\*\* Note - It shall be mandatory to record the energy supplied separately for each category of consumers which is being provided a separate rate of subsidy in the tariff, by the state government, so that the subsidy due for the electricity distribution company is quarterly calculated by multiplying the energy supplied to each of such category of consumers by the applicable rate of subsidy notified by the state government.**

Circle code	Parameter
	Please enter name of circle
	Please enter circle code
0	Please enter numeric value or 0
	Formula protected

I/We undertake that the information supplied in this Document and Pro-forma is accurate to the best of my knowledge and if any of the information supplied is found to be incorrect and such information result into loss to the Central Government or State Government or any of the authority under them or any other person affected, I/we undertake to indemnify such loss.

Authorised Signatory and Seal

Signature:-  
Name of Energy Manager:  
Registration Number:

Name of Authorised Signatory:

Name of the DISCOM:

Full Address:-

Seal





**Details of Input Energy Sources**

Period From: APRIL 2021 to MARCH 2022

B. Generation at Transmission Feeder(s) (Details)

S.No	Name of Generating Station	Generating Capacity (in MW)	Type of Station (Generation) (Normal, Standby, Cold, Spinning Reserve, etc.) (Station Regulated MW level)	Type of Fuel used for generation (if any)	Type of Grid (State or International)	Point of Connection (PCC) (Line No.)	Voltage Level (kV or higher)	Remarks (Percent of time)
1	Chambare	5	Steam	and August 2021	0000-0000			
2	WPP (0000)	5	Steam	May-12	0000-0000			
3	WPP (10 MW)	10	Steam	Dec-12	0000-0000			
4	Pharwa Raj	4.2	Steam	February 2021	0000-0000			
5	Raj Power	2.768	Steam	Apr-06	0000-0000			
6	Indraprastha	2.812	Steam	Apr-06	0000-0000			
7	GAPEL	5	Steam	Mar-08	0000-0000			
8	Ajmer	50	Steam	201-18	0000-0000			
9	WPP (at WPP-IV)	50	Steam	Dec-12	0000-0000			
10	Sarabamba	5	Water	Mar-02	0000-0000			
11	Solar Power Plant (M)	50	Water	Dec-09	0000-0000			
12	MPV Raj Power	2.05	Water	Aug-12	0000-0000			
13	Royal Raj Solar (WPP)	2	Water	Apr-17	0000-0000			
14	Majra PCC (W)	2.88	Water	Dec-18	0000-0000			
15	Jaipur	2.21	Water	Dec-18	0000-0000			
16	Madhav Dams (WPP)	2.4	Steam	Apr-17	0000-0000			
17	Kedia Dams	2.7	Steam	December 1988	0000-0000			
18	Kedia Dams (WPP)	1.24	Steam	Mar-17	0000-0000			
19	Raj (old)	2.828	Steam	18-08	0000-0000			
20	Durgam Dam	2.43	Steam		0000-0000			
21	Raj Raj (WPP)	2	Steam	1982 and July 2018	0000-0000			
22	Swati Island	2.212	Steam		0000-0000			
23	Mirzapur	2	Steam	2004	0000-0000			
24	Mirzapur (WPP)	2.2	Steam	18-18	0000-0000			
25	Kajrat Raj	2.204	Steam	and March 2020	0000-0000			
26	Long Island	2.84	Steam	Dec-09	0000-0000			
27	Kanpur	2.817	Steam		0000-0000			
28	Kadamtak	2.812	Steam	2004	0000-0000			
29	Nanghat (WPP)	2.4	Steam	Aug-18	0000-0000			
30	MS Nagar	2.6	Steam	1987	0000-0000			
31	CHP	2.26	Hydro	Aug-01	0000-0000			
32	Smith Island (WPP)	2.248	Steam	Nov-12	0000-0000			
33	Saraha Nagar (WPP)	2.852	Steam	Nov-12	0000-0000			
34	Abadi Nagar (WPP)	2.08	Steam	Oct-12	0000-0000			
35	Saraha Nagar (WPP)	2.248	Steam	12-12	0000-0000			
36	Ch. Noida (WPP)	2	Steam	2005 and Jan 2018	0000-0000			
37	Ch. Noida (WPP)	2.984	Steam	Mar-02	0000-0000			
38	Kanara	2.024	Steam		0000-0000			
39	Changpur	2.076	Steam		0000-0000			
40	Kashid (WPP)	2.26	Steam		0000-0000			
41	Upper Kachid	2	Steam		0000-0000			
42	Kashid (WPP)	2	Steam	Mar-02	0000-0000			
43	Orissa	2.1	Steam		0000-0000			
44	Teesta	2.214	Steam		0000-0000			
45	Coastal Raj	2.26	Steam	Jan-07	0000-0000			
46	Bunder Raj	2.028	Steam		0000-0000			
47	Durgam	2.012	Steam		0000-0000			
48	Madhwa	2.812	Steam		0000-0000			
49	Changpur	2.014	Steam		0000-0000			
50	Mursh	2.214	Steam		0000-0000			
51	Wai	2.214	Steam		0000-0000			
52	Wai Raj	2.012	Steam		0000-0000			
53	Madhwa	2.012	Steam		0000-0000			
54	Madhwa	2.012	Steam		0000-0000			
55	Raj Raj	2.012	Steam		0000-0000			
56	Morcha	2.02	Steam		0000-0000			
57	Bangor	2.024	Steam		0000-0000			



(Details of Feeder-wise losses)

Period from APRIL 2023 to MARCH 2024

Sl No.	State	Received at Circle (In MU)	Received at Division (In MU)	Received at Sub-division (In MU)	Name of the Station	Feeder Code/ID	Feeder Name	Type of Feeder (Urban/Rural/District/Industrial/Other)	Type of Feeder meter (AMR/AMM/Other)	Received at Feeder (Feet In MU)	Feeder Consumption (In MU)	Final Net Export at Feeder Level (In MU)	T&D losses	AT&C losses	% Data Received through Automaticity of Meter AMR/AMM	Remarks
					Chautha		Chautha			6.41		217.81				
					JDP (DMS)		Wala 2			5.95						
					JDP (DMS)		Chokha			5.62						
					Phonka Bay		Halka			9.88						
					Bag Nivari		34			2.48						
					Sectorial		Heal 2/4			4.00						
					Agri-Plant/NFLC (AMR)		Esar			8.59						
							Harua			7.69						
					JDP 10.5.047-19		Rasa Feeder			6.198						
							Khajhar			6.51						
							Haradpur			6.87						
							Agari Feeder			6.88						
							Chandpur Feeder			7.88						
							Dandpur Feeder			15.73						
							Bagpura			6.08						
							Mary Feeder			13.99						
							Prithviraj			9.88						
							Murwaha			16.61						
							Dahyari			18.06						
							Haradwala			6.52						
							Chakrapur			15.78						
							Chandhali			15.88						
							Dandia Baramahal			3.55						
							Chakur Feeder			7.11						
							Sala			27.58						
							Bhadra/NFLC (AMR) & T&D			8.11		77.74				
							Madhali (Sarvagand)			12.83						
							Chakur Feeder			16.89						
							Raja Feeder			12.34						
							Shahdol Damang (Indra)			6.36						
							Banoli Damang (Indra)			18.81						
							Banoli Damang (Siva)			6.17						
							Banoli Damang (Shri)			0.034						
							Rudum			0.05						
							Chakura Creek			14.43						
							Mad Bay (Indra)			0.18						
							Orcha Damang			0.18						
							Banoli			0.028		22.20				
							Banoli (Indra)			5.88						
							Banoli (Shri)			18.11						
							Long Damang			6.48						
							Champali			6.00						
							Badli Tala			6						
							Banoli (Indra)			18.41						
							She Nagar			15.57		22.53				
							Shear			14.47						
							Shear Damang (Indra)			0.84						
							Shear Damang (Shri)			8.11						
							Shear Nagar (Indra)			0.053						
							Shear Nagar (Shri)			0.071						
							Car Washar Kanyuka			7.88		18				
							Car Washar (Indra)			0.013						
							Chautha			2.52						
							Chandpur			6.29						
							Chandpur (OPM)			0.93						
							Chandpur			6.24						
							Chandpur			0.44						
							Chandpur Bay			6.26						